

☎ 400-021-3388



**上海禾益净化设备制造有限公司**  
SHANGHAI HEFIL PURIFYING EQUIPMENT MANUFACTURING CO.,LTD.

**禾益（浙江）环境科技有限公司**  
HEFIL-TECH(ZHEJIANG) ENVIRONMENTAL CO., LTD.

总部地址：上海市松江区G60科技城中心路1450号2#18楼

浙江工厂：浙江国家级平湖经济技术开发区兴工路1555号

邮编：201601 网址：www.hefil.com 邮箱：sales@hefil.com

客服：400-021-3388 总机：021-67632998

Headquarters Add:18th, T2, Phase II, Science and Technology Oasis, No. 1450, Zhongxin Road, Songjiang District, Shanghai

Zhejiang Factory:No. 1555, Xingong Road, Pinghu Economic & Technological Development Zone, Zhejiang Province

Post: 201601 Website: www.hefilter.com E-mail: echo@hefil.com

Custom Service Hotline: 400-021-3388 Switchboard: 021-67632998



Facebook



Made In China



Website



官网



微博



微信公众号

BETTER AIR BETTER LIFE



## 医药与生物安全解决方案

PHARMACEUTICAL & BIO-SAFETY SOLUTIONS

**上海禾益净化设备制造有限公司**  
SHANGHAI HEFIL PURIFYING EQUIPMENT MANUFACTURING CO.,LTD.  
**禾益（浙江）环境科技有限公司**  
HEFIL-TECH(ZHEJIANG) ENVIRONMENTAL CO., LTD.

# COMPANY INTRODUCTION

## 企业介绍

上海禾益净化设备制造有限公司创建于2001年（上海禾滤），所拥有的禾益（HEFIL）品牌享誉国内外。禾益致力于空气过滤器、化学过滤器、耐高温过滤器、风机过滤单元（FFU）及各类净化设备和洁净室产品的研发、制造、批发、零售及相关技术服务。禾益拥有先进的全电脑控制无隔板空气过滤器、有隔板空气过滤器和折叠式滤芯全自动生产线，具备完善的检测手段和洁净室无尘车间。

禾益生产的各类净化过滤产品广泛应用于生物制药、医疗卫生、实验室、集成电路、半导体、航天航空、核工业、电子产品、食品加工、机电设备、化工、涂装、汽车制造及环境保护等各个领域。禾益已成功获得ISO9001:2015质量体系认证和ISO14001环境体系认证；禾益的产品已通过SGS、RoHS、UL认证。禾益公司已成功通过高新技术企业认证，正式成为高新企业之一。

禾益始终以尽善尽美的品质、售前售后的服务致力于市场的开拓。禾益产品销量逐年提升，市场占有率不断提高，公司充分贯彻“以质量服务求生存、以品牌求市场”的经营方针，产品相继在北京、上海、江苏、浙江、安徽、山东、广西、四川、海南、重庆、湖北、广东、湖南、河南、河北、山西、陕西、云南、台湾、马来西亚、墨西哥、新加坡、澳大利亚、印度、加拿大、日本、美国、德国等国内外地区拥有自己的客户群体。

公司不仅重视销售市场的拓展，更重视企业员工素质的提高，以高素质的人力资源作为企业资本。公司特聘业内研发工程师、业内技术人才致力于产品的研发制造，重视企业员工的培训和教育，崇尚“创造、挑战”的企业精神，造就了一批朝气蓬勃、敬业创新的制造团队。



禾益环境上海工厂



禾益环境浙江工厂

Shanghai HEFIL Purifying Equipment Manufacturing Co., Ltd was founded in 2001, and it has a reputation of HEFIL brand at home and abroad. HEFIL is devoted to the development, manufacturing, wholesale and retail of air filters, chemical filters, high temperature resistance filters, fan filter units, HEFIL provide support with research and development, manufacture, wholesale, retail and relative technical service for the custom purifying equipment and clean room products, HEFIL has the most advanced computer-controlled automatic production lines for the production of mini-pleat panel air filters, air filters and cartridge filters, HEFIL have excellent detection method and one hundred thousand grade clean room.

All kinds of purification and filtration products made by HEFIL are widely used in biopharmaceutical, health and medical community, laboratory, semiconductor, aviation and astronautics, integrated circuit, nuclear industry, electronics industry, food processing industry, electromechanical device, chemical industry, spraying, automobile industry, environmental protection and other related fields. HEFIL has successfully obtained ISO 9001:2008 quality management system certification and ISO14001 environmental management system certification; HEFIL products have been certified by SGS / ROHS / UL; HEFIL succeed pass through the certificate of new high-tech enterprise and formly became one of the high-tech enterprise.

HEFIL always makes efforts in market development with the perfect quality, the good pre-sales and after-sales services. HEFIL fully implement the guideline in business – "Survival Depends on Quality and Service; Markets Rely on Price and Brand". HEFIL product sales are improving year by year, and the product's market share continues to increase. One after another, in Beijing, Shanghai, Jiangsu, Zhejiang, Anhui, Shandong, Guangxi, Sichuan, Hainan, Chongqing, Hubei, Guangdong, Hunan, Henan, Hebei, Shanxi, Shanxi, Yunnan, Taiwan, Japan, United States, Germany, Russia and so on, HEFIL products have their own customer base.

Moreover, paying more attention to improve the quality of employees, the company is taking high quality human resources as a business capital, and it has specialized in hiring senior research engineer, senior technical personnel dedicated to product development and manufacturing. Attaching importance to training and education of employees, and advocating "The More Challenging, the More Innovation" the spirit of enterprise, the Company has created an excellent manufacturing team, which is vibrant, dedicated and innovative.



禾益环境上海办公楼

# CONTENT

## 画册目录

公司概况	01
COMPANY PROFILE	01
医药生物行业主要合作客户	02
PHARMACEUTICAL & BIO-SAFETY INDUSTRY CLIENTS	02
企业资质	02
COMPANY CERTIFICATES	02
公司组织图	03
HEFIL COMPANY ORGANIZATION CHART	03
生产制造与产品检测	03
MANUFACTURING AND PRODUCT DETECTION	03
展会风采展示	04
EXHIBITION SHOW	04
客户参观	04
CLIENTS VISIT	04
生物制药解决方案	05-06
BIOPHARMACEUTICAL SOLUTIONS	05-06
GMP介绍	07-08
GMP INTRODUCTION	07-08
HMG 无隔板液槽式过滤器	09-10
HMG GEL SEAL MINI-PLEAT PANEL FILTER	09-10
HFU 无隔板PTFE过滤器	11-12
HFU MINI-PLEAT PTFE FILTER	11-12
HMU 无隔板超高效平板式过滤器	13-14
HMU MINI-PLEAT ULPA PANEL FILTER	13-14
HTR 耐高温过滤器	15-16
HIGH TEMPERATURE RESISTANCE FILTER	15-16
HBM 化纤袋式过滤器	17-18
SYNTHETIC POCKET FILTER	17-18
HPP 初效板式折叠过滤器	19-20
PRIMARY-EFFICIENCY PANEL FILTER	19-20
HHD 液槽 / 高效送风口	21-22
GEL SEAL / HEPA DIFFUSER	21-22
FFU 风机过滤单元	23-24
FAN FILTER UNIT	23-24
防爆下拆式风机过滤单元	25-26
EXPLOSION-PROOF LOWER DETACHABLE FAN FILTER UNIT	25-26
EFU 超薄设备风机过滤单元	27-28
EQUIPMENT FAN-FILTER UNIT	27-28
HNP 负压称量罩、取样罩	29-30
NEGATIVE PRESSURE WEIGHING BOOTH, SAMPLING BOOTH	29-30
HLB 洁净层流罩	31-32
CLEAN LAMINAR BOOTH	31-32
HBIBO 袋进袋出过滤装置	33-35
BAG-IN / BAG-OUT FILTER HOUSING	33-35
HWS 不锈钢洗手池	36
HWS Hand-washing sink	36
PUSH PUSH 过滤器	37-38
PUSH PUSH FILTER	37-38
高效捕集袋	39-40
HIGH EFFICIENCY TRAPPING BAG	39-40
HAS 风淋室	41-42
AIR SHOWER	41-42
HBO 洁净工作棚	43-44
HBO CLEAN BOOTH	43-44
HCB 洁净工作台	45-46
HCB CLEAN BENCH	45-46
HBX 自净传递窗	47-48
HBX LAMINAR PASS BOX	47-48
HRPB 防爆层流传递窗	49-50
EXPLOSION-PROOF LAMINAR FLOW TRANSFER WINDOW	49-50
HVHP 过氧化氢传递窗	51-52
HYDROGEN PEROXIDE TRANSFER WINDOW	51-52
HBX 过氧化氢无菌隔离器	53-54
HYDROGEN PEROXIDE STERILE ISOLATORS	53-54
HFL 不锈钢液体过滤器	55-56
HFL LIQUID FILTER	55-56
HFG 不锈钢气体过滤器	57-58
HFL GAS FILTER	57-58
HJD 不锈钢多袋式过滤器	59-60
HJD STAINLESS STEEL MULTI-BAG FILTER	59-60
HCFE 聚四氟乙烯微孔膜折叠式滤芯	61-62
HCFL PTFE MEMBRANE MEDIA FILTER CARTRIDGE	61-62
HCPP 聚丙烯折叠式滤芯	63-64
HCPP PP MEDIA FILTER CARTRIDGE	63-64
HDPE 过滤袋	65-66
HDPE LIQUID FILTER BAG	65-66

# COMPANY PROFILE

## 公司概况

- 2001年:** 上海禾滤净化技术有限公司正式成立于上海宝山区  
HEFIL was originally founded in baoshan, Shanghai
- 2005年:** 禾益净化扩建从上海宝山区迁至上海松江区  
Due to expansion, HEFIL moved to songjiang district, Shanghai
- 2006年:** 禾滤、禾益净化两家公司合并，注册资金一千万元  
HEFIL's registered capital reach up to ten million RMB.
- 2007年:** 禾益净化因业务量涨幅新增德国进口MADA数控机床  
Based on business increasement, HEFIL imported MADA numerically-controlled machine from Germany.
- 2008年:** 禾益净化因追求更高端品质新增美国进口PAO检测设备  
To provide much higher quality, HEFIL brought in America imported PAO testing equipment.
- 2009年:** 禾益净化年产值超5000万元  
HEFIL annual output value exceeds 50 million RMB
- 2010年:** 禾益工厂再次扩建，拥有超过5000m<sup>2</sup>的自有工厂，并重建10万级净化等级的专业无尘车间  
HEFIL further expanded to 5000m<sup>2</sup> and upgrated the air cleanliness workshop to class 100,000
- 2011年:** 禾益净化正式成为上海室内环境协会理事会员  
HEFIL was officially nominated as a member of Shanghai Association of Indoor Environment.
- 2012年:** 禾益净化引进韩国高折波、超幅宽的全自动折纸生产线  
HEFIL brought in Korean Sumsung automatic origami production machine.
- 2013年:** 禾益质量管理体系已成功获得ISO9001:2008认证  
HEFIL quality managerment system have succeed pass through the certificate of ISO9001:2008
- 2014年:** 禾益产品通过SGS、RoHS等认证  
HEFIL products have succeed pass through the certification of SGS, RoHS etc.
- 2015年:** 禾益产品通过美国最高防火等级UL、BV质量体系等认证  
HEFIL products passed certification of UL, BV etc.  
禾益公司成功通过高新技术企业认证，正式成为高新企业之一  
HEFIL was successfully nominated as high-tech enterprise
- 2016年:** 禾益环境荣获松江区“专精特新”中小企业证书  
HEFIL Environment was awarded the certificate of "Specialized and Specialized" SME in Songjiang District
- 2017年:** 禾益净化美国加州分公司成立并运营  
HEFIL have establishment and operating as a branch on California, USA
- 2018年:** 禾益净化年产值突破1.5亿  
HEFIL annual output value over than 150 million RMB
- 2019年:** 禾益净化通过专精特新认证以及ISO14001:2015环境管理体系认证  
HEFIL pass through the certification of specialized, fined, peculiar and new and ISO4001:2015
- 2020年:** 禾益环境设备（平湖总部）项目签约落户平湖经济开发区  
HEFIL Environmental Equipment (Pinghu Headquarters) Project Signed and Settled in PINHU
- 2021年:** 禾益环境再次被评定为“高新技术企业”  
HEFIL Environment was again evaluated as "High-tech Enterprise".
- 2022年:** 禾益（浙江）环境科技有限公司奠基仪式在浙江平湖经济技术开发区举行  
HEFIL-TECH(ZHEJIANG) ENVIRONMENTAL CO., LTD. Groundbreaking ceremony held in Zhejiang PINHU ECPNOMIC-TECHNOLOGICAL DEVELOPMENT ZONE
- 2023年:** 禾益环境松江区G60科技城独立办公楼装修开工  
Renovation of independent office building in G60 Science and Technology Oasis in Songjiang District of HEFIL Environment started

官方网站:  
www.hefilter.com

website:  
www.hefilter.com

总部所在地:  
Address:

松江区G60科技城中心路1450号2#18楼  
18th, T2, Phase II, Science and Technology Oasis, No. 1450, Zhongxin Road, Songjiang District, Shanghai  
上海市松江高科技园区沧泾路151号  
No.151 Cangjing Rd., Songjiang High-tech Park, Shanghai

## 医药生物行业主要合作客户 PHARMACEUTICAL & BIO-SAFETY INDUSTRY CLIENTS



## COMPANY CERTIFICATES 企业资质



# HEFIL COMPANY ORGANIZATION CHART 公司组织图

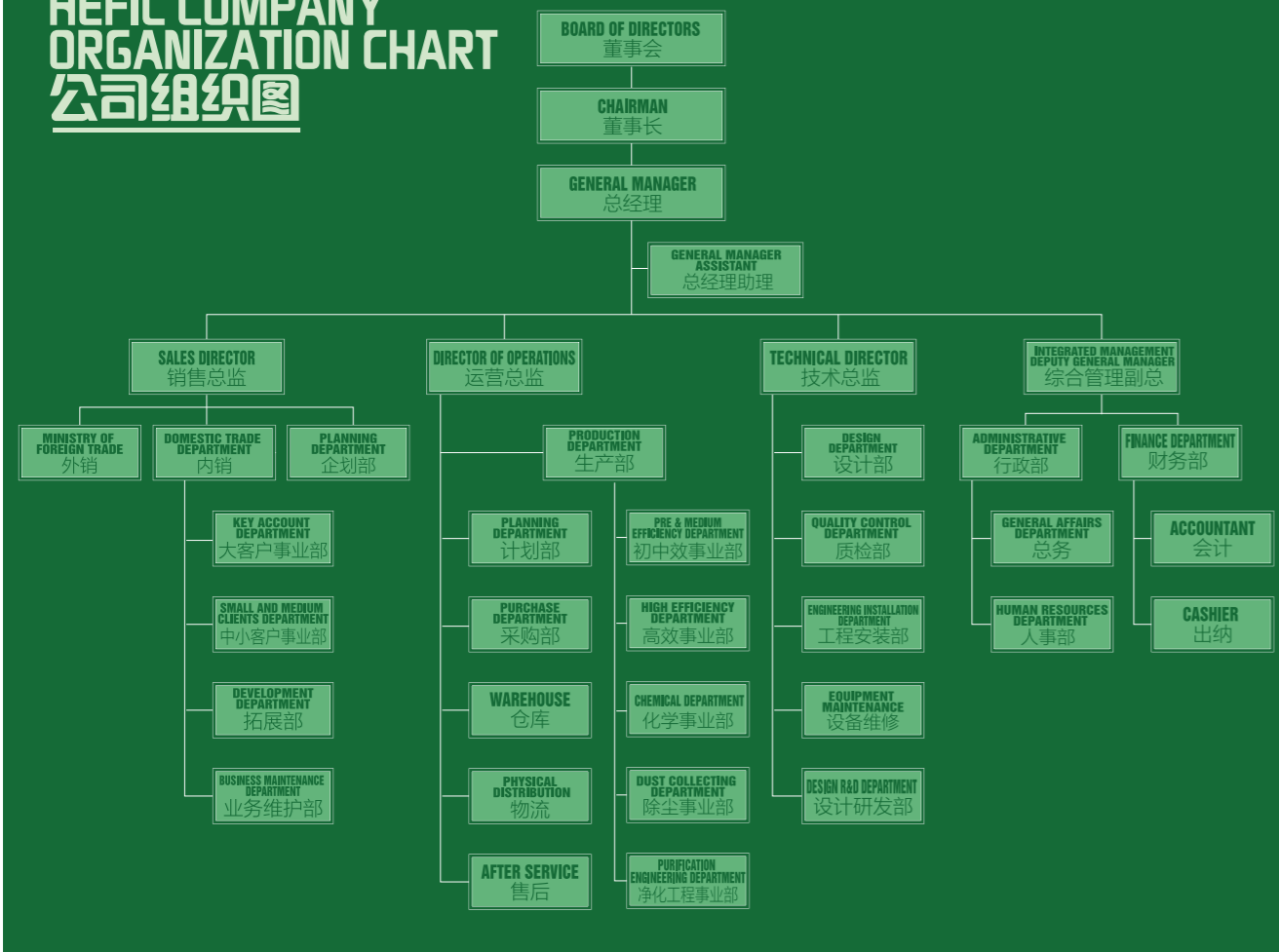

## EXHIBITION SHOW 展会风采展示



## MANUFACTURING AND PRODUCT DETECTION 生产制造与产品检测



## CLIENTS VISIT 客户参观



# BIOPHARMACEUTICAL SOLUTIONS

## 生物制药解决方案



HCPE PTFE膜四叠之端微孔膜折囊式滤芯  
PTFE Membrane Media Filter Cartridge



HCMS 熔喷滤芯  
Melt Spinning Filter Cartridge



HPEF PE滤袋  
PE Bag Filter



HCPP PP聚丙烯折囊式滤芯  
PP Media Filter Cartridge



HCSW 线绕式滤芯  
String Wound Filter Cartridge



HCPS 聚醚砜折囊式滤芯  
PES Membrane Media Filter Cartridge



HCNL 尼龙折囊滤芯  
N6 Membrane Media Filter Cartridge



HTSF 四氟滤袋  
Polytetrafluoroethylene(PTFE) Sintered Filter Core

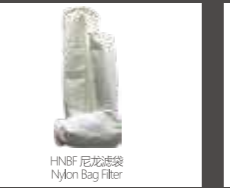

HNBF 尼龙滤袋  
Nylon Bag Filter



HPPF PP滤袋  
HPPF PP Bag Filter



HFL 液体过滤器  
Liquid Filter

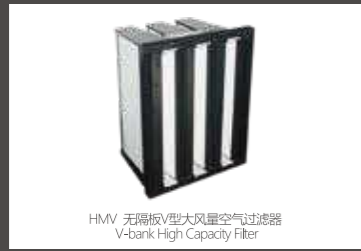

HMV 无隔板/型大风量空气过滤器  
V-bank High Capacity Filter



HBP 不织布袋式过滤器  
Non-woven Pocket Filter



HPP 折囊式初效板式过滤器  
Folded Primary Filter

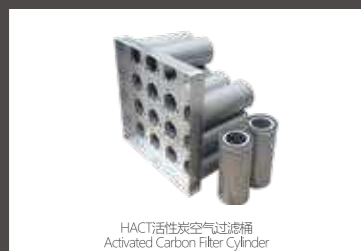

HACT 活性炭空气过滤器  
Activated Carbon Filter Cylinder

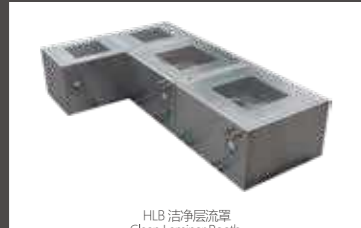

HLB 洁净层流罩  
Clean Laminar Booth

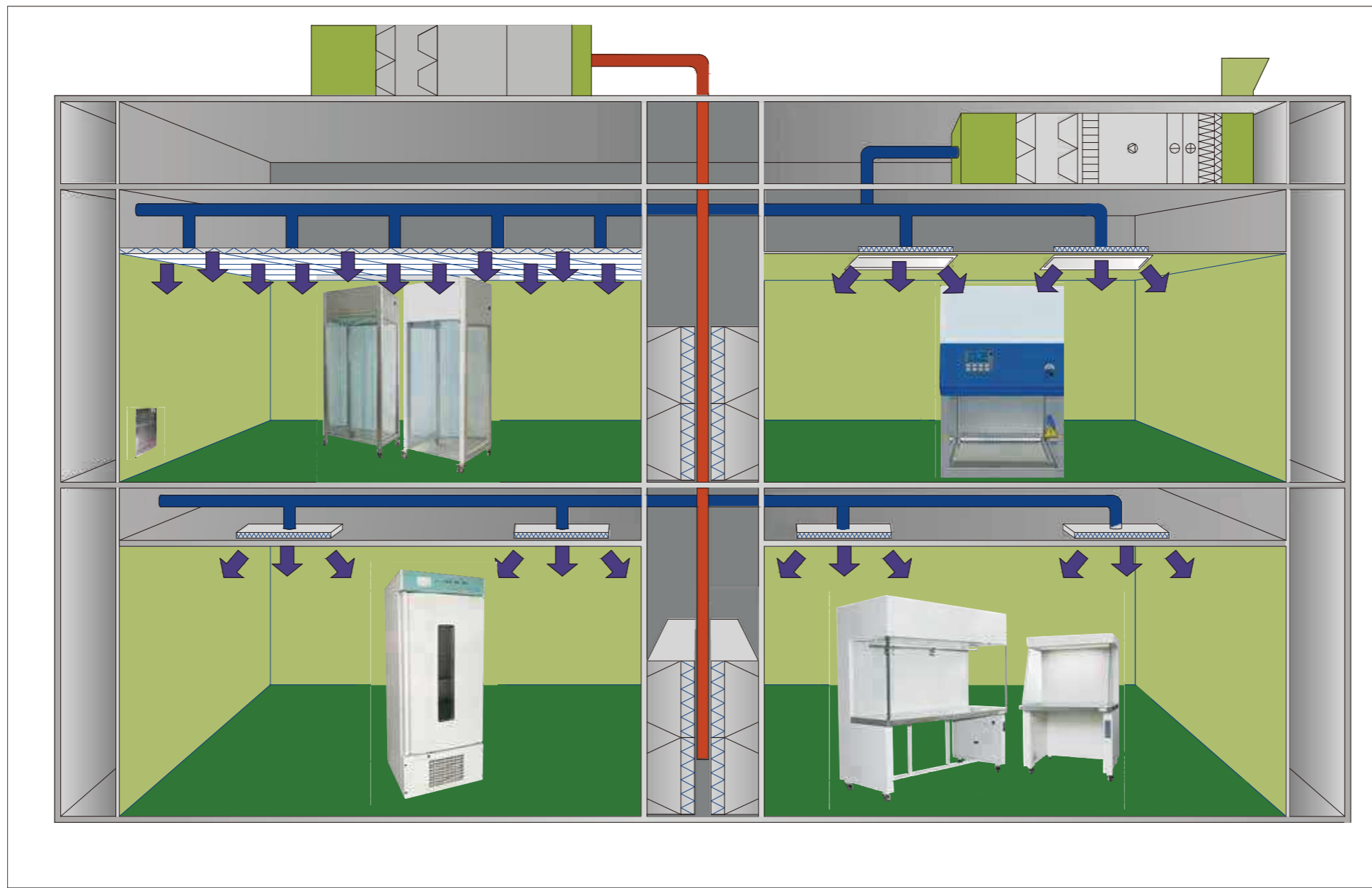

HFG 气体过滤器  
Gas Filter



HHD 液槽 / 高效送风口  
GEL SEAL / HEPA DIFFUSER

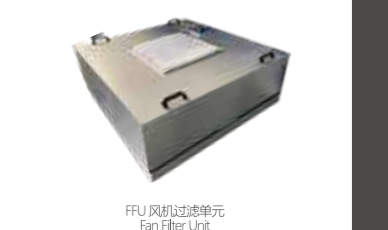

FFU 风机过滤单元  
Fan Filter Unit



HMG 无隔板液槽式过滤器  
Gel Seal Mini-pleat Panel Filter



HRPB 防爆层流传递窗  
HRPB Explosion-proof laminar flow transfer window



不锈钢洗手池  
Hand-washing sink



HBO 洁净工作棚  
HBO Clean Booth



HAS 风淋室  
HAS Air Shower



HBEO 袋进袋出过滤器  
Bag-in/ Bag-out Filter Housing



HSFC 钛合金烧结滤芯  
Titanium alloy Sintered Filter Core



HCB 洁净工作台  
HCB Clean Bench



HBSC 安全生物柜  
Biological Safety Cabinet



HVHP 过氧化氢传递窗  
HYDROGEN PEROXIDE TRANSFER WINDOW



HXB 过氧化氢无菌隔离器  
HYDROGEN PEROXIDE STERILE ISOLATORS



HRPB 防爆层流传递窗  
Explosion-proof laminar flow transfer window

# GMP INTRODUCTION

## GMP介绍



GMP是《药品生产质量管理规范》(Good Manufacturing Practice, GMP)的英文缩写,是对企业生产过程的合理性、生产设备的适用性和生产操作的精确性、规范性提出强制性要求。最新版《药品生产质量管理规范(2010年修订)》已于2010年10月19日经卫生部常务会议审议通过,现予以发布,自2011年3月1日起正式施行。

GMP是药品生产和质量管理的基本准则,适用于药品制剂生产的全过程和原料药生产中影响成品质量的关键工序,大力推行药品GMP,是为了最大限度地避免药品生产过程中的污染和交叉污染,降低各种差错的发生,是提高药品质量的重要措施。

目前,在中国生产的药品全球范围的销售要求制造商不但要符合中国的2010版GMP规范,还要符合国际标准EU/GMP, FDA-cGMP的要求。

GMP没有详细列出生物洁净室的设计、建造、测试、等方面的要求。详细内容还要参照相关的GMP实施指南,药品GMP认证检查评定标准, FED209E, ISO14644, ISO14698, IEST, 国际GB/T, EN1822等标准。

洁净室和污染控制技术是保证GMP成功实施的主要手段之一。

GMP is called Good Manufacture Practice, is a compulsory requirement for rationality of the manufacturing process of enterprise, applicability of manufacturing equipment and accuracy and normalization of operation. The latest GMP (2010) was deliberated and approved on 19<sup>th</sup> Oct, 2010, it has been published now and it's implemented from 1<sup>st</sup> Mar, 2011.

GMP is basic principle for medicine production and quality control. It's applicable for overall process of medicament manufacturing and key process of material medicine manufacturing which affects end product quality. Promoting GMP vigorously, is to avoid contamination and cross contamination during process of medicine manufacturing farthest, it's also an important measure to reduce mistakes and improve the medicine quality.

At present, sales of medicine made in China should not only accord with requirement of GMP but also requirement of EU/GMP and FDA-cGMP

GMP hasn't listed detailed requirements of design, construction, test etc for Bio-clean room. Details items should refer to related GMP implementation guide, GMP compliance standard, FED 209E, ISO14644, ISO14698, IEST, GB/T, EN1822, etc.

Clean room and pollution control technology is one of the important measures of ensuring successful implement of GMP.

### 生物洁净室相关标准 Bio Clean Room Related Standard

标准 Standard	洁净度等级 Cleanliness Level	洁净室测试 Clean Room Test	HEPA过滤器分级 HEPA Filter Grading	HEPA过滤器测试 HEPA Filter Test
美国 FDA / GMP	US FED 209 D & E	IEST-PR-CC00 6.3 IEST-PR-CC023.1	IES-PR-CC001.4	IEST-PR-CC006.3 IEST-PR-CC0021.2 IEST-PR-CC0034.2
欧盟 EU / GMP	GGMP EEC Annex 1 ISO14644	ISO14644-2 & 3 ISO14698	EN1822	EN1822
中国 GMP-2011	FED 209 D & E ISO14644-1	GB 50073-2001 GB/T 16292-2010 GB/T 16293-2010 GB/T 16294-2010	GB/T 13554-2008	GB/T 6165-2008

### 空气的洁净度 Air Clean Class

生物洁净室空气洁净区分为四个区域:

A级——高风险操作区,即直接影响操作的区域。像隧道灭菌、无菌灌装、瓶子开口处、高压灭菌冷却区等需用100级层流。直接影响产品质量,称A级。

B级——间接影响无菌操作区,直接环绕A级区域的地方,像无菌灌装房间、高压灭菌冷却房间。

C和D级——进入无菌生产区的过渡性洁净区。准备间、更衣室和缓冲间。

Biology clean-room air cleanliness has four classes:

Class A-high-risk operation area, is the area has direct influence to operation, Tunnell sterilizing oven, sterile filling, bottle opening area, High pressure sterilization cooling zone, etc. All need use 100 class laminar flow. Which affects product quality directly, called class A. Class B-Indirectly affects sterile area. directly surrounds class A area like sterile filling room and high pressure sterilization cooling room.

Class C&D-transitional cleaning area entering into sterile manufacturing area, preparing room, dressing room and buffer room.

洁净级别 Cleanliness Class	尘粒最大允许数/m <sup>3</sup> Mote Max Allowable no./m <sup>3</sup>		微生物数量最大允许数 Microbial Amount Max Allowable no		风速要求m/s Velocity
	>0.5um	>5um	浮游菌/m <sup>3</sup> Floating/m <sup>3</sup>	沉降菌/m <sup>3</sup> Sediment bacteria/m <sup>3</sup>	
A级(动态百级) Class A (dynamic hundred class)	3.5x10 <sup>3</sup> / 3.5x10 <sup>3</sup>	0 / 0	1	0.125	0.36-0.54
B级(静态百级) Class B (static hundred class)	3.5x10 <sup>3</sup> / 3.5x10 <sup>3</sup>	0/2.0x10 <sup>3</sup>	10	0.625	—
C级(10000) Class C	3.5x10 <sup>5</sup> / 3.5x10 <sup>6</sup>	2.0x10 <sup>3</sup> / 2.0x10 <sup>4</sup>	100	6.25	—
D级(100000) Class D	3.5x10 <sup>6</sup> / -----	2.0x10 <sup>4</sup> / -----	200	12.5	—

### GMP中悬浮粒子分级的不同标准的大致对比 GMP Airborne Particles Classification Standards Rough Comparison

中国 GMP-1998	中国 GMP-2010	US FED 209D	US FED 209E	ISO14644-1	EU/GMP Annex 1	建议末端过滤器
100(动态) (Dynamic)	A	100(动态) (Dynamic)	M3.5(动态) (Dynamic)	ISO5(静态) (Static)	A	H14
100(静态) (Static)	B	100(静态) (Static)	M3.5(静态) (Static)	ISO5(静态) (Static)	B	H14
10000	C	10000	M5.5	ISO7	C	H14
100000	D	100000	M6.5	ISO8	D	H14
300000	-	-	M7	-	-	H11

### 空气过滤器效率规格对比 Air Filter Efficiency Spec. Compariso

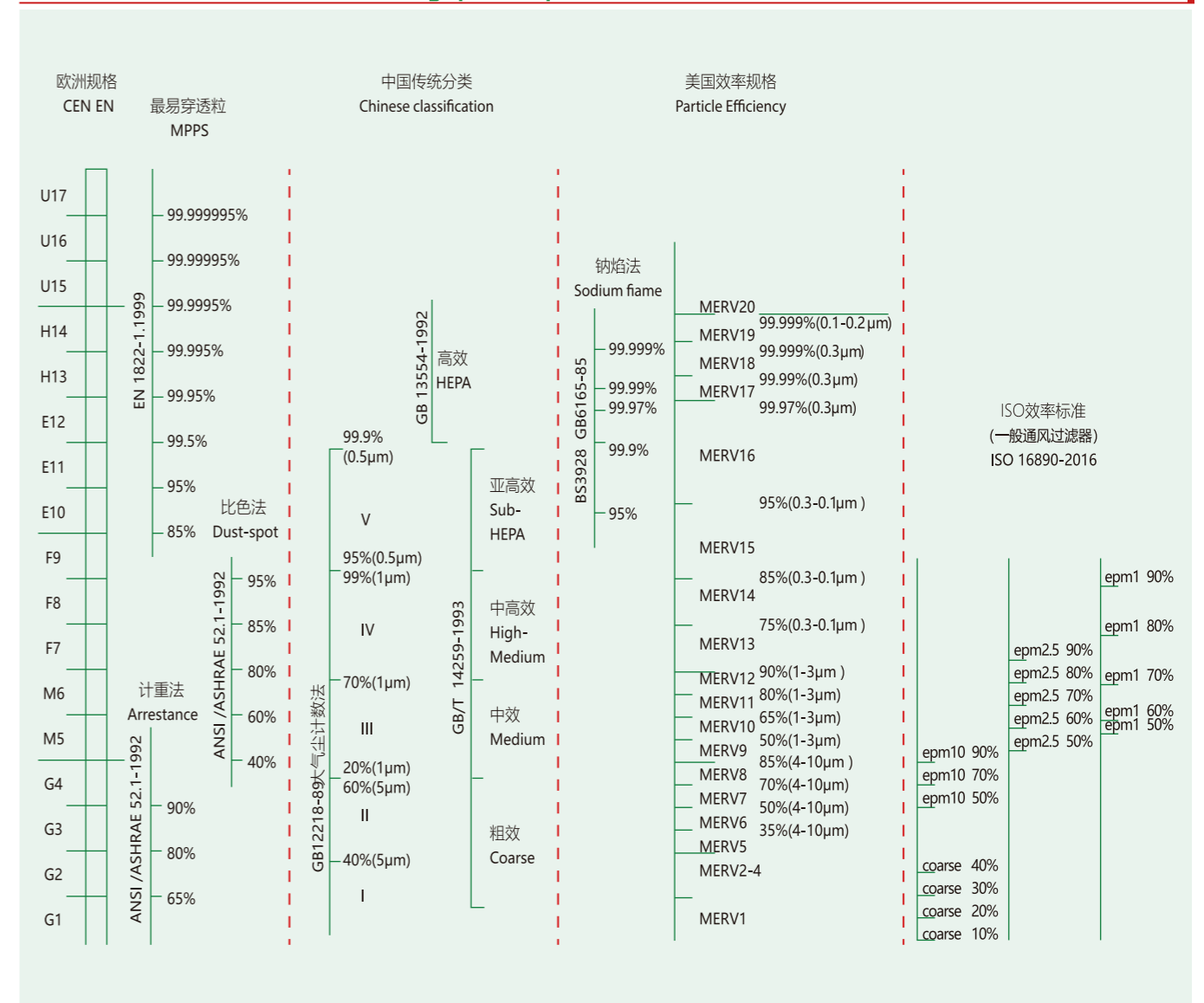

# GEL SEAL MINI-PLEAT PANEL FILTER

## HMG 无隔板液槽式过滤器



### 材质说明 Material Instructions

结构: L型侧液槽、Y型顶液槽两种  
 滤料: 采用超细玻纤滤纸  
 外框: 阳极氧化铝型材  
 分隔物: 热熔胶  
 密封胶: 聚氨酯  
 耐温: ≤90°C

Structure: L-type side gel seal, Y-type top gel seal.  
 Media: Ultra-fine fiberglass filter paper.  
 Frame: Anodized aluminum alloy.  
 Separator: Hot-melt glue.  
 Sealant: Polyurethane.  
 Temperature: Maximum 90°C in continuous service.



# GEL SEAL MINI-PLEAT PANEL FILTER

## HMG 无隔板液槽式过滤器

### 产品介绍 Production Introduction

HMG 无隔板液槽式高效过滤器主要用于补集0.3μm以下的颗粒灰尘及各种悬浮物, 作为各种过滤系统的末端过滤产品。广泛应用于生物医药、医疗卫生、食品加工、光学电子、LCD液晶制造、精密仪器、饮料食品、PCB印刷等行业无尘净化车间的空调末端送风处, 高效和超高效过滤器均用于洁净室末端。

HMG 具有过滤效率高、阻力低、容尘量大等特点, 最大限度地满足客户的各种应用场合的要求, Ultrair H 的外形尺寸可根据客户要求定制;

HMG 过滤器严格按照EN1822标准进行设计、生产、检测。EN1822是目前国内最新的、最完善的、基于MPPS的逐台激光扫描的测试标准;

符合GB/T 13554-2008《高效空气过滤器》、GB/T 6165-2008《高效空气过滤器性能试验方法过滤效率和阻力》等国家标准, 同时也符合美国IEST-RPCC034标准。

HMG gel seal mini-pleat panel filter is mainly used for capture dust and all kinds of suspended solids with diameter below 0.3μm, as the final for all kinds of filtration system. It is widely used in air condition terminal air supply place of dust-proof room of Bio-pharma, medical care, food processing, optical electron, LCD manufacturing, precision instrument, beverage and food. PCB printing and other industries. HEPA and ULPA are both applicable for clean-room end.

HMG has the feature of high efficiency, low resistance, large dust holding and etc, can meet customer's requirements for all kinds of applications farthest, The size of HMG can be customized.

HMG filter was designed, produced and tested according to EN 1822 standard strictly. EN1822 is the latest and most complete testing standard by laser scanning based on MPPS (MPPS is normally between 0.1-0.25μm)

Accord with GB/T 13554-2008"HEPA filter", GB/T 14295-2008" filter", GB/T 6165-2008" HEPA filter performance testing method, efficiency and resistance" etc also acoord with American IEST-RPCC034

### 优势 Advantage

- ◆ 过滤效率等级H14~U17可供选择
- ◆ 用电脑控制的全自动折叠机系统进行喷胶折叠, 折叠高度范围可在18~96 mm之间无级调节, 幅宽可达1240mm
- ◆ 专用超细玻璃纤维滤纸作为滤材, 带来稳定的过滤效率
- ◆ 双面保护网, 保护滤料, 增加强度
- ◆ 槽内填充进口蓝色果冻胶
- ◆ 轻薄型, 结构紧凑
- ◆ 每台ULPA均按EN1822:2009标准经过测试

- ◆ Filter efficiency ranges from H14 to U17.
- ◆ Adopt computer-controlled automatic production line for manufacturing, the crest height of folding filter material can be regulated steplessly between 18~96 mm, width will reach 1240mm at the widest.
- ◆ Use special ultra-fine fiberglass paper as the filter media, good stability of filtration efficiency.
- ◆ Imported blue jelly glue filled
- ◆ Double side guard mesh, protect the filter material, good strength.
- ◆ Light in weight, compact in structure.
- ◆ Each ULPA / HEPA filter is tested according to EN1822:2009.

### 应用 Application

- ◆ 主要用于生物制药、医疗卫生、医院实验室、电子、无尘室、高效送风口、层流设备等要求超高洁净度的场合。
- ◆ Suitable for biopharming, health and medical community, hospital laboratory, electronics, clean room, HEPA diffuser, laminar flow devices and the occasions require ultra-high cleanliness.

### 常用规格 Common Specifications

型号 Model	外形尺寸 Dimensions WxHxD (mm)	过滤面积 Media Area (m²)	额定风量 Rated Air Flow (m³/h)	初始压降 Initial Pressure Drop (Pa)
HMG610/10-70L	610×610×70	9.5	800	≤ 220@H14
HMG610/03-93L	305×305×93	2.7	250	
HMG610/05-93L	305×610×93	5.9	500	
HMG610/10-93L	610×610×93	13.0	1000	
HMG610/15-93L	915×610×93	20.0	1500	
HMG610/20-93L	1220×610×93	27.0	2000	
HMG610/03-104Y	305×305×104	3.4	320	≤ 250@H14
HMG610/05-104Y	305×610×104	6.8	640	
HMG610/10-104Y	610×610×104	13.9	1280	
HMG610/15-104Y	915×610×104	20.9	1920	
HMG610/20-104Y	1220×610×104	28.0	2560	

注: 1、若遇规格、结构变更, 以本公司提供的最新数据为准; 有关更新内容请关注本公司网站: www.hefil.com

2、本公司接受非表上规格过滤网产品的订货。

Note: 1. In case of specifications or structures changes, HEFIL will provide up-to-date data on website: www.hefilter.com.

2. HEFIL makes various of other models' HMG gel seal mini-pleat panel filter which are not listed in above table. Please consult with us if you need.

### 结构示意图 Structure Drawings

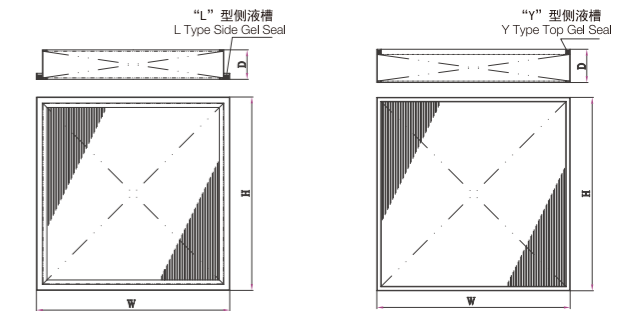

### 初始压降与风量性能曲线图 The Initial Pressure Drop and Rated Air Flow Performance Curve

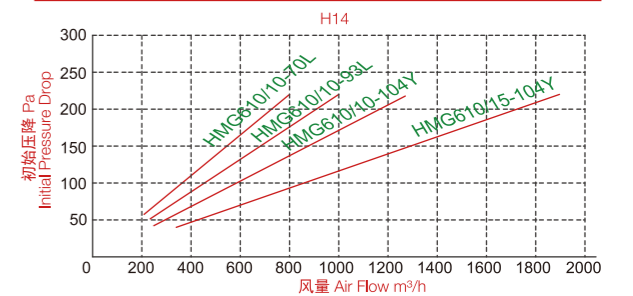

# HFU MINI-PLEAT PTFE FILTER

## HFU 无隔板PTFE过滤器



### 材质说明 Material Instructions

过滤效率: E10~U17 (EN1822)  
 框架: 阳极氧化铝型材  
 框架可选厚度: 50 / 70 / 90 (mm)  
 滤料: PTFE进口滤膜  
 护面网: 烤漆钢板网 / 铝板网

Filter efficiency: E10~U17 (EN1822)  
 Frame: Anodized aluminum alloy  
 Thickness of frame: 50 / 70 / 90 (mm)  
 Media: Imported PTFE membrane  
 Guard mesh: Painted steel expanded / Aluminum expanded



# HFU MINI-PLEAT PTFE FILTER

## HFU 无隔板PTFE过滤器

### 产品介绍 Production Introduction

PTFE无隔板过滤器在恶劣环境中, 具有优秀耐酸(包括氟酸)、耐碱性、耐有机物质之特性。轻巧且高韧度, 较强的抗损坏性。挥发性(无硼)的洁净材质, 减少不纯物废气的释出量(硼、钾、矽等); 无金属污染物。压力损失与一般玻纤材料相比降低约50%从而降低能源消耗。节省空间及减轻重量。

The PTFE mini-pleat filter have character of withstand acid, alkali and organic material in harsh environment, It have the advantage of lightness high tenacity and strong resistance to damage, the volatility boron-free media can be to reduced the release amount of impure waste gas(boron, potassium, silicon etc.); no metallic pollutant; damage due to pressing compare with general fiber glass paper can be loss about 50% then reduce the energy consumption, it also can save space and reduce the weight.

### 优势 Advantage

- ◆ 过滤效率可达99.99%以上
  - ◆ 用电脑控制的全自动折叠机系统进行喷胶折叠, 折叠高度范围可在18~96mm之间无级调节, 幅宽可达1240mm
  - ◆ 专用PTFE滤料作为滤材, 使用寿命长
  - ◆ 双面护网, 保护滤料, 强度高
  - ◆ 轻薄型, 结构紧凑
  - ◆ 每台过滤器均按EN1822:2009标准经过测试
- ◆ Filter efficiency could be above on 99.99%
  - ◆ Adopt computer-controlled automatic production line for manufacturing, the crest height of folding filter material can be regulated steplessly between 18-96mm,width will reach 1240mm at the widest.
  - ◆ The special PTFE media have a long service life.
  - ◆ The aim of double side guard mesh to be protect the media and have a good strength.
  - ◆ Light in weight,compact in structure.
  - ◆ Each one of ULPA / HEAP filter to be tested based on EN1822:2009

### 应用 Application

- ◆ 主要用于电子、医药行业、无尘室、FFU、层流设备等要求高洁净度的场合的终端过滤
- ◆ Apply to electronics, pharmaceutical industry, hospital, and the occasions required the high cleanliness terminal filtration

### 结构示意图 Structure Drawings

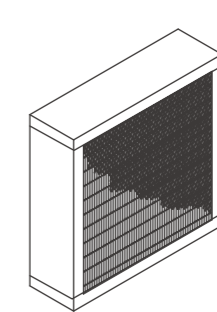

0号框体: 金属板框 四周全平  
 Frame: Metal, Flat Structure

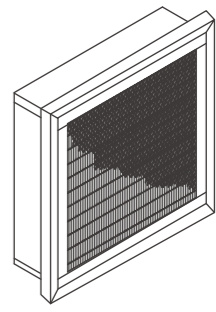

1号框体: 金属板框 单凸法兰  
 Frame: Metal, Single Side Flange

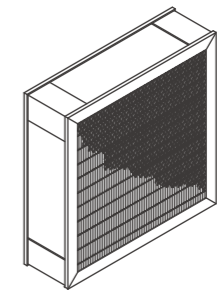

A1号框体: 铝合金单层型材  
 Frame: Single Layer Aluminum Alloy

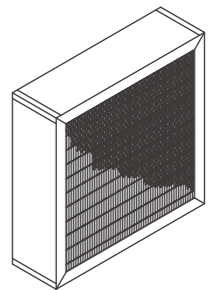

A2号框体: 铝合金双层型材  
 Frame: Double Layers Aluminum Alloy

### 常用规格 Common Specifications

型号 Model	外形尺寸 Dimensions WxHxD (mm)	过滤面积 Media Area (m <sup>2</sup> )	额定风量 Rated Air Flow (m <sup>3</sup> /h)	初始压降 Initial Pressure Drop (Pa)
HFU 305/10-50	305×305×50	1.6	200	≤ 102@H14
HFU 610/05-50	305×610×50	3.3	400	
HFU 610/10-50	610×610×50	6.7	820	
HFU 570/20-50	1170×570×50	12	1440	
HFU 1170/10-50	1170×1170×50	24	2950	

注: 1、若遇规格、结构变更, 以本公司提供的最新数据为准; 有关更新内容请关注本公司网站: www.hefil.com  
 2、本公司接受非表上规格过滤网产品的订货。

Note: 1. In case of specifications or structures changes, HEFIL will provide up-to-date data on website: www.hefilter.com.

2. HEFIL makes various of other models' HMF mini-pleat PTFE filter which are not listed in above table. Please consult with us if you need.



# HMU MINI-PLEAT ULPA PANEL FILTER

## HMU 无隔板超高效平板式过滤器



### 材质说明 Material Instructions

滤料: 采用超细玻璃纤维纸、PTFE滤纸  
 外框: 阳极氧化铝型材、不锈钢  
 分隔物: 热熔胶  
 密封胶: 聚氨酯  
 耐温: ≤ 90°C

Media: Ultra-fine fiberglass or PTFE filter paper.  
 Frame: Anodised aluminum or stainless steel.  
 Separator: Hot-melt glue.  
 Sealant: Polyurethane.  
 Temperature: Maximum 90°C in continuous service.



# HMU MINI-PLEAT ULPA PANEL FILTER

## HMU 无隔板超高效平板式过滤器

### 产品介绍 Production Introduction

超高效无隔板空气过滤器是用超细玻璃纤维纸等制作而成,用热熔胶作分隔物,与金属外框组合而成。主要捕集0.12μm以下的尘粒。用于洁净室末端送风口, FFU、洁净设备等安装, 以及要求较高的送风系统。

The ULPA filter is made of Ultra-fine fiber glass filter paper and other materials and it uses hot-melt adhesive as the partition material to form with the metal frame. It is mainly used for catching dust with the particle size of 0.12μm and below. It is installed at the end air supply outlet of clean rooms, FFU and clean equipment and air supply systems with high requirements.

### 优势 Advantage

- ◆ 过滤效率等级U15~U17可供选择
- ◆ 用电脑控制的全自动折叠机系统进行喷胶折叠, 折叠高度范围可在18~96 mm之间无级调节, 幅宽可达1240mm
- ◆ 专用超细玻璃纤维滤纸作为滤材, 带来稳定的过滤效率
- ◆ 双面保护网, 保护滤料, 增加强度
- ◆ 轻薄型, 结构紧凑
- ◆ 每台ULPA均按EN1822:2009标准经过测试
- ◆ Filter efficiency ranges from U15 to U17.
- ◆ Adopt computer-controlled automatic production line for manufacturing, the crest height of folding filter material can be regulated steplessly between 18~96 mm, width can be reached 1240mm .
- ◆ Use special ultra-fine fiberglass filter paper as the filter material, good stability of filtration efficiency.
- ◆ Double side guard mesh, protect the filter media, good strength.
- ◆ Light in weight, compact in structure.
- ◆ Each ULPA filter is tested according to EN1822:2009.

### 应用 Application

- ◆ 主要用于生物制药、医疗卫生、医院实验室、电子、无尘室、FFU、层流设备等要求超高洁净度的场合。
- ◆ Suitable for biopharming, health and medical community, hospital laboratory, electronics, clean room, FFU, laminar flow devices, and the occasions require ultra-high cleanliness.

### 常用规格 Common Specifications

型号 Model	外形尺寸 Dimensions WxHxD (mm)	过滤面积 Media Area (m <sup>2</sup> )	额定风量 Rated Air Flow (m <sup>3</sup> /h)	初始压降 Initial Pressure Drop (Pa)
HMU305/10-50	305x305x50	1.6	150	≤250@H14
HMU610/05-50	305x610x50	3.3	300	
HMU610/10-50	610x610x50	6.7	600	
HMU570/20-50	1170x570x50	12	1300	
HMU1170/10-50	1170x1170x50	24	2600	
HMU610/05-70	305x610x70	5.5	500	
HMU610/10-70	610x610x70	11.3	1000	
HMU610/15-70	915x610x70	17.0	1500	
HMU610/20-70	1220x610x70	22.7	2000	
HMU570/10-70	570x570x70	9.7	900	
HMU570/20-70	1170x570x70	20.4	1800	
HMU1170/10-70	1170x1170x70	40.8	3600	
HMU610/10-90	610x610x90	15.4	1300	
HMU610/15-90	915x610x90	23.2	2000	
HMU610/20-90	1220x610x90	31.1	2600	

注: 1、若遇规格、结构变更, 以本公司提供的最新数据为准; 有关更新内容请关注本公司网站: www.hefil.com

2、本公司接受非表上规格过滤网产品的订货。

Note: 1. In case of specifications or structures changes, HEFIL will provide up-to-date data on website: www.hefilter.com.

2. HEFIL makes various of other models' HMU mini-pleat ulpa panel filter which are not listed in above table. Please consult with us if you need.

### 结构示意图 Structure Drawings

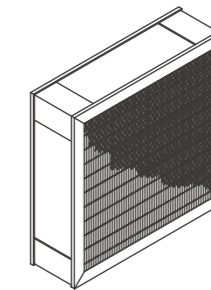

A1号箱体: 铝合金单层型材  
Frame: Single Layer Aluminum Alloy

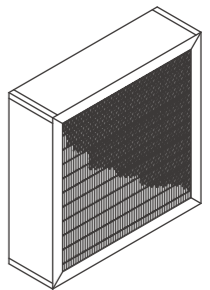

A2号箱体: 铝合金双层型材  
Frame: Double Layers Aluminum Alloy

### 初始压降与风量性能曲线图 The Initial Pressure Drop and Rated Air Flow Performance Curve

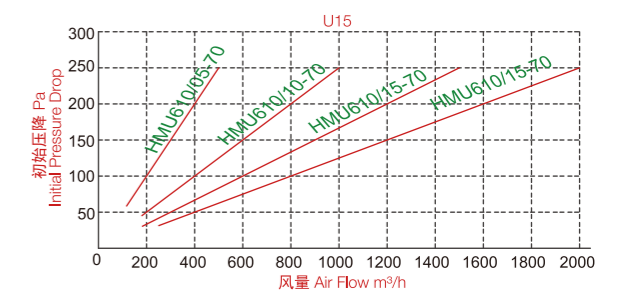

# HIGH TEMPERATURE RESISTANCE FILTER HTR 耐高温过滤器



## 材质说明 Material Instructions

滤料: 特制玻璃纤维滤纸  
外框: 不锈钢外框, 隔板式结构  
分隔物: 特种铝箔分隔片  
密封胶: 特种耐高温密封胶  
耐温: 德国进口耐高温陶瓷胶水耐温高达400°C

Media: Special fiberglass paper.  
Frame: Stainless steel.  
Separator: Special aluminum foil.  
Sealant: Special temperature resistant silica gel.  
Temperature: up to 400°C high temperature resistant ceramic glue imported from Germany.



# HIGH TEMPERATURE RESISTANCE FILTER HTR 耐高温过滤器

## 产品介绍 Production Introduction

耐高温有隔板过滤器是适用于过滤粒径 $\leq 0.3-0.5\mu\text{m}$ 的洁净室和净化房, 常温、常湿, 允含量有微量酸、碱、有机溶剂的空气过滤器, 广泛应用于航空、航天、电子、制药、生物工程等各个领域。

The high temperature resistance HEPA is suitable for filtering dust with the particle size of  $\leq 0.3-0.5\mu\text{m}$  in clean rooms, purification rooms, ambient temperature and ambient humidity. It is an air filter that can withstand light acid, alkaline and organic solvents. The product has been broadly used in aviation, aerospace, electronics, pharmaceutical production, biological engineering, etc.

## 优势 Advantage

- ◆ 过滤效率等级E10~H14可供选择
- ◆ 不锈钢外框配以特种耐高温密封材料, 耐温400°C
- ◆ 专用折叠设备进行折叠
- ◆ 特制玻璃纤维滤纸作为滤材, 带来稳定的过滤效率
- ◆ 特种铝箔间隔片
- ◆ 可带双面护网, 保护滤料, 强度高
- ◆ 每台过滤器经抗挥发处理并严格检测
- ◆ 每台HEPA过滤器都通过EN1822:2009标准
- ◆ 通过国际UL认证、SGS报告
- ◆ Filter efficiency ranges from E10 to H14.
- ◆ Stainless steel frame with special high temperature gasket, operating temperature can reach 400°C.
- ◆ Adopt special folding machine for manufacturing.
- ◆ Use special fiberglass paper as the filter material, good stability of filtration efficiency.
- ◆ Use special aluminum foil as separator.
- ◆ Metal meshes as supporter in double sides, effectively protect filter media and make the whole filter in good strength.
- ◆ Each filter is through rigorous test after anti-evaporation treatment.
- ◆ Each HEPA filter is tested according to EN1822: 2009.
- ◆ Passed international UL certification and SGS test report.

## 应用 Application

- ◆ 主要用于超净烘箱、超净清洗机、化工行业等要求高温空气净化的设备及系统。
- ◆ Suitable for clean drying oven, clean washing machine, chemical industry and other high-temperature air purification equipment and systems.

## 结构示意图 Structure Drawings

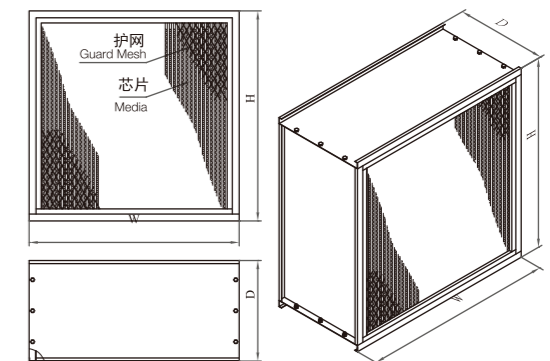

## 初始压降与风量性能曲线图 The Initial Pressure Drop and Rated Air Flow Performance Curve

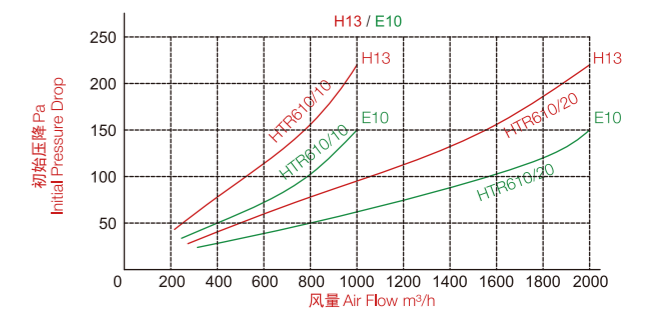

## 常用规格 Common Specifications

型号 Model	外形尺寸 Dimensions WxHxD (mm)	过滤面积 Media Area (m²)		额定风量 Rated Air Flow (m³/h)		初始压降 Initial Pressure Drop (Pa)			
		标准 Standard	高风量 High Capacity	标准 Standard	高风量 High Capacity	E10	H12	H13	H14
HTR320	320x320x220	4.1	6.1	350	525	≤ 160	≤ 200	≤ 235	≤ 255
HTR484/10	484x484x220	9.6	14.4	1000	1500				
HTR484/15	726x484x220	14.6	21.9	1500	2250				
HTR484/20	968x484x220	19.5	29.2	2000	3000				
HTR630/05	315x630x220	8.1	12.1	750	1200				
HTR630/10	630x630x220	16.5	24.7	1500	2250				
HTR630/15	945x630x220	24.9	37.3	2200	3300				
HTR630/20	1260x630x220	33.4	50.1	3000	4500				
HTR610/03	305x305x150	2.4	3.6	250	375				
HTR610/05	305x610x150	5.0	7.5	500	750				
HTR610/10	610x610x150	10.2	15.3	1000	1500				
HTR610/15	915x610x150	15.4	23.1	1500	2250				
HTR610/20	1220x610x150	20.6	30.9	2000	3000				
HTR610/05X	305x610x292	10.1	15.1	1000	1500				
HTR610/10X	610x610x292	20.9	31.3	2000	3000				

注: 1、若遇规格、结构变更, 以本公司提供的最新数据为准; 有关更新内容请关注本公司网站: www.hefil.com  
2、本公司接受非表上规格过滤网产品的订货。

Note: 1. In case of specifications or structures changes, HEFIL will provide up-to-date data on website: www.hefilter.com.

2. HEFIL makes various of other models' HTR high temperature resistance filter which are not listed in above table. Please consult with us if you need.

# SYNTHETIC POCKET FILTER

## HBM 化纤袋式过滤器



### 材质说明 Material Instructions

滤料: 采用复合化学纤维布  
 外框: 镀锌框、铝合金框、不锈钢框或塑框, 框体厚度通常有21mm、25mm、45mm  
 耐温: ≤90°C

Media: Composite chemical fiber non-woven.  
 Frame: Galvanized plate, aluminum, stainless steel plate or plastic, the usual thickness are 21mm, 25mm or 45mm.  
 Temperature: Maximum 90°C in continuous service.



# SYNTHETIC POCKET FILTER

## HBM 化纤袋式过滤器

### 产品介绍 Production Introduction

化纤袋式过滤器广泛适用于空调系统的中级过滤, 适应于含尘浓度高的场合, 采用优质复合化纤无纺布料, 容尘量大。主要用于过滤1-5μm的尘埃的粒子, 具有阻力小、风量大的优点。

HBM synthetic pocket filter is widely used in the intermediate filtration of air conditioning systems. It is suitable for high dust concentration and high quality composite chemical fiber non-woven filter material. It is mainly used to filter particles of 1-5 μm dust, which has the advantages of low resistance and large air volume.

### 优势 Advantage

- ◆ 过滤效率等级G3~F9可供选择
- ◆ 采用特制的高通量低阻力复合化学纤维布作为滤材, 容尘量大
- ◆ 可带铝合金框、镀锌框、塑框或不锈钢框
- ◆ 通过UL国际认证, 符合EN779:2012标准
- ◆ Filter efficiency ranges from G3 to F9.
- ◆ Use special low-resistance and high-throughput composite chemical fiber non-woven as the filter material, high dust-holding capacity.
- ◆ The filter frame is made of aluminum alloy, galvanized steel, stainless steel or plastic.
- ◆ Have passed international UL certification and meet EN779:2012.

### 应用 Application

- ◆ 主要用于电子、生物制药、机械仪表和石化轻工等行业的一般空气净化系统和机场、地铁、大型商场等公共服务场所。
- ◆ Suitable for the electronics, bio-pharmaceutical, machinery, instrumentation, petrochemical and light industry as general air purification systems and airport, subway, shopping malls and other public service places.

### 结构示意图 Structure Drawings

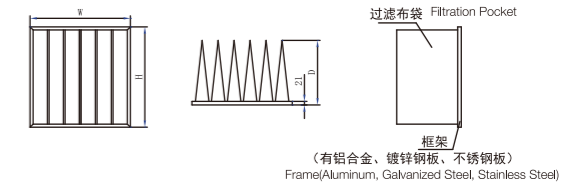

### 初始压降与风量性能曲线图 The Initial Pressure Drop and Rated Air Flow Performance Curve

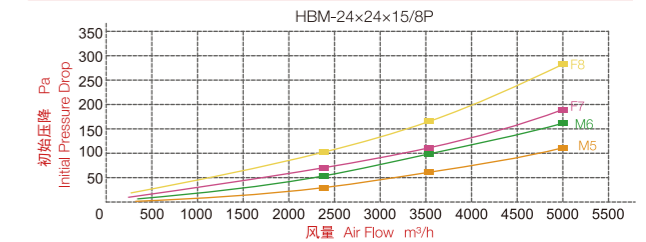

### 常用规格 Common Specifications

型号 Model	外形尺寸 Dimensions WxHxD (mm)	袋数 No. of Pockets	过滤面积 Media Area (m²)	各效率规格的初始压降@额定风量 Initial Pressure Drop (Pa) @ Rated Air Flow (m³/h)								
				G3 30~35%	G4 30~35%	M5 40~45%	M6 60~65%	F7 80~85%	F8 90~95%	F9 90~95%		
HBM-24x24x24-8P	592x592x600	8	6.5	22@3400	27@3400	38@3400	58@3400	68@3400	98@3400	108@3400		
HBM-24x24x22-8P	592x592x558		6.1	24@3400	29@3400	41@3400	62@3400	73@3400	104@3400	114@3400		
HBM-24x24x18-8P	592x592x450		4.9	30@3400	36@3400	51@3400	77@3400	91@3400	98@2550	108@2550		
HBM-24x24x15-8P	592x592x381		4.2	37@3400	42@3400	59@3400	90@3400	106@3400	114@2550	124@2550		
HBM-24x24x12-8P	592x592x300	6	3.4	47@3400	52@3400	73@3400	111@3400	98@2550	141@2550	151@2550		
HBM-24x24x24-6P	592x592x600		5	30@3400	35@3400	50@3400	76@3400	89@3400	96@2550	106@2550		
HBM-24x24x22-6P	592x592x558		4.7	33@3400	38@3400	53@3400	81@3400	94@3400	102@2550	112@2550		
HBM-24x24x18-6P	592x592x450		3.8	42@3400	47@3400	65@3400	100@3400	126@2550	136@2550			
HBM-24x24x15-6P	592x592x381	6	3.3	49@3400	54@3400	75@3400	86@2550	101@2550	145@2550	155@2550		
HBM-24x24x12-6P	592x592x300		2.6	63@3400	68@3400	95@3400	109@2550	85@1700	123@1700	133@1700		
HBM-20x24x24-6P	490x592x600		4.9	31@3400	36@3400	51@3400	77@3400	90@3400	98@2550	108@2550		
HBM-20x24x22-6P	490x592x558		4.6	33@3400	38@3400	54@3400	82@3400	96@3400	104@2550	114@2550		
HBM-20x24x18-6P	490x592x450	6	3.7	43@3400	48@3400	67@3400	102@3400	90@2550	130@2550	140@2550		
HBM-20x24x15-6P	490x592x381		3.2	50@3400	55@3400	78@3400	89@2550	104@2550	150@2550	160@2550		
HBM-20x24x12-6P	490x592x300		2.6	63@3400	68@3400	95@3400	109@2550	85@1700	123@1700	133@1700		
HBM-20x20x24-5P	490x490x600		5	3.5	33@2550	38@2550	53@2550	81@2550	95@2550	137@2550	147@2550	
HBM-20x20x22-5P	490x490x558	3.3		35@2550	40@2550	57@2550	86@2550	101@2550	148@2550	158@2550		
HBM-20x20x18-5P	490x490x450	2.7		44@2550	49@2550	67@2550	105@2550	82@1700	118@1700	128@1700		
HBM-20x20x15-5P	490x490x381	2.3		53@2550	58@2550	81@2550	82@1700	96@1700	139@1700	149@1700		
HBM-20x20x12-5P	490x490x300	5	1.8	69@2550	74@2550	67@1700	105@1700	123@1700	89@850	99@850		
HBM-12x24x24-4P	287x592x600		4	3.2	22@1700	27@1700	38@1700	58@1700	68@1700	98@1700	108@1700	
HBM-12x24x22-4P	287x592x558			3	24@1700	29@1700	41@1700	73@1700	82@1700	104@1700	114@1700	
HBM-12x24x18-4P	287x592x450			2.4	31@1700	36@1700	51@1700	77@1700	91@1700	98@1275	108@1275	
HBM-12x24x15-4P	287x592x381	2.1		37@1700	42@1700	59@1700	90@1700	106@1700	114@1275	124@1275		
HBM-12x24x12-4P	287x592x300	4	1.7	47@1700	52@1700	73@1700	111@1700	98@1275	141@1275	151@1275		
HBM-12x24x24-3P	287x592x600		3	2.5	30@1700	35@1700	50@1700	76@1700	89@1275	96@1275	106@1275	
HBM-12x24x22-3P	287x592x558			2.3	33@1700	38@1700	53@1700	81@1700	94@1700	102@1275	112@1275	
HBM-12x24x18-3P	287x592x450			1.9	42@1700	47@1700	65@1700	100@1700	88@1275	126@1275	136@1275	
HBM-12x24x15-3P	287x592x381	1.6		49@1700	54@1700	75@1700	86@1275	91@1275	145@1275	155@1275		
HBM-12x24x12-3P	287x592x300	3	1.3	63@1700	68@1700	95@1700	109@1275	85@850	123@850	133@850		

注: 1、若遇规格、结构变更, 以本公司提供的最新数据为准; 有关更新内容请关注本公司网站: www.hefil.com  
 2、本公司接受非表上规格过滤网产品的订货。

Note: 1. In case of specifications or structures changes, HEFIL will provide up-to-date data on website: www.hefilter.com.  
 2. HEFIL makes various of other models' HBM synthetic pocket filter which are not listed in above table. Please consult with us if you need.

# PRIMARY-EFFICIENCY PANEL FILTER

## HPP 初效板式折叠过滤器



### 材质说明 Material Instructions

滤料: 采用化学纤维布, 单面附网折叠或带龙骨架折叠  
 外框: 纸质、镀锌钢板、不锈钢板、铝合金或塑料外框  
 耐温: ≤90°C

Media: Non-woven fabrics with pleated mesh supporter or metal pillar.  
 Frame: Cardboard, galvanized steel sheet, stainless steel sheet, aluminum alloy or plastic.  
 Temperature: Maximum 90°C in continuous service.



# PRIMARY-EFFICIENCY PANEL FILTER

## HPP 初效板式折叠过滤器

### 产品介绍 Production Introduction

初效板式折叠式空气过滤器适用于空调系统的初级过滤, 主要用于过滤5μm以上尘埃粒子, 过滤器的四周皆以特殊的专业粘合胶水与外框粘合, 能防止空气泄漏或因风阻压力造成破损的情况发生。

The primary efficiency panel filter is suitable for primary filtration of air conditioning systems and is mainly used to filter dust particles above 5μm. the filter is surrounded by special adhesive glue to the outer frame to prevent air leakage or damage due to windage pressure.

### 优势 Advantage

- ◆ 过滤效率等级G3-M5可供选择, 对≥5.0μm颗粒的过滤效率在40%~60%
- ◆ 采用特制的高通量低阻力化学纤维布作为滤材, 容尘量大
- ◆ 有纸质、镀锌钢板、不锈钢板、铝合金或塑料外框
- ◆ 符合EN779:2012标准
- ◆ Filtration efficiency rating from G3 to M5, traps 40~60% of ≥5.0μm particles.
- ◆ Use special low-resistance and high-throughput non-woven fabrics as the filter material, with high dust-holding capacity.
- ◆ There are cardboard, galvanized steel sheet, stainless steel sheet, aluminum alloy or plastic frame.
- ◆ Meet EN779:2012.

### 应用 Application

- ◆ 主要作为高效过滤器的预过滤和房间通风系统的净化过滤和机场、地铁、大型商场等公共服务场所。
- ◆ Suitable as pre-filter used to protect high-performance filters, and filtration of fresh air in clean room ventilation system and airport, subway, shopping malls and other places of public services.

### 常用规格 Common Specifications

型号 Model	外形尺寸 Dimensions WxHxD(mm)	额定风量 Rated Air Flow (m³/h)		初始压降 Initial Pressure Drop (Pa)		过滤面积 Media Area (m²)	折距 Pitch (mm)	
		标准 Standard	高风量 High Capacity	标准 Standard	高风量 High Capacity			
HPP-12x24x1	290x595x23	600	1200	20	63	0.40	19	
HPP-20x14x1	493x341x23	550	1100			0.39		
HPP-20x15x1	493x366x23	625	1250			0.43		
HPP-20x16x1	493x391x23	650	1300			0.45		
HPP-20x20x1	493x493x23	800	1600			0.56		
HPP-20x24x1	493x595x23	950	1900			0.65		
HPP-24x24x1	595x595x23	1200	2400			0.83		
HPP-25x14x1	620x341x23	700	1400			0.48		
HPP-25x16x1	620x391x23	800	1600			0.57		
HPP-25x20x1	620x493x23	1000	2000			0.71		
HPP-14x20x2	341x493x46	850	1700			0.77		20
HPP-20x12x2	493x290x46	700	1400			0.70		
HPP-20x16x2	493x391x46	900	1800			0.94		
HPP-20x18x2	493x442x46	1050	2100			1.01		
HPP-20x20x2	493x493x46	1200	2400	1.12				
HPP-24x12x2	595x290x46	850	1700	0.79				
HPP-24x18x2	595x442x46	1300	2600	1.24				
HPP-24x20x2	595x493x46	1400	2800	1.36				
HPP-24x24x2	595x595x46	1700	3400	1.64				
HPP-25x16x2	620x391x46	1200	2400	1.18				
HPP-25x18x2	620x442x46	1350	2700	1.27				
HPP-25x20x2	620x493x46	1500	3000	1.42				
HPP-20x16x4	493x391x96	950	1900	1.45	18	68		
HPP-20x20x4	493x493x96	1200	2400	1.73				
HPP-24x12x4	595x290x96	850	1700	1.28				
HPP-24x18x4	595x442x96	1300	2600	1.91				
HPP-24x20x4	595x493x96	1400	2800	2.09				
HPP-24x24x4	595x595x96	1700	3400	2.55				
HPP-25x16x4	620x391x96	1200	2400	1.82				
HPP-25x20x4	620x493x96	1500	3000	2.18				
HPP-25x29x4	620x721x96	2150	4300	3.27				

注: 1、若遇规格、结构变更, 以本公司提供的最新数据为准; 有关更新内容请关注本公司网站: www.hefil.com

2、本公司接受非表上规格过滤网产品的订货。

Note: 1. In case of specifications or structures changes, HEFIL will provide up-to-date data on website: www.hefilter.com.

2. HEFIL makes various of other models' HPP primary-efficiency panel filter which are not listed in above table. Please consult with us if you need.

### 结构示意图 Structure Drawings

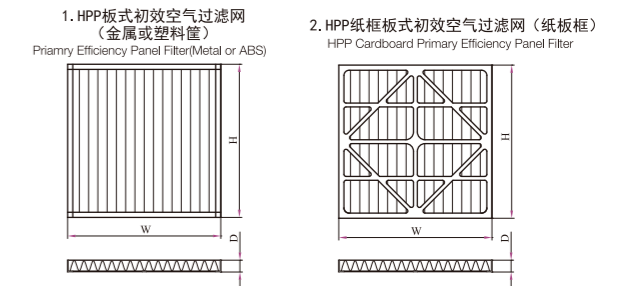

### 初始压降与风量性能曲线图 The Initial Pressure Drop and Rated Air Flow Performance Curve

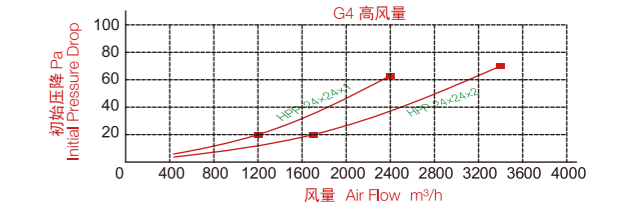

# GEL SEAL / HEPA DIFFUSER

## HHD 液槽 / 高效送风口



### 材质说明 Material Instructions

箱体材质: 优质冷轧钢板, 表面静电喷塑  
 过滤材料: 超细玻纤滤纸  
 散流面板: 出风面散流面板材质为铝质喷塑、冷轧钢板喷塑或不锈钢L型为液槽型高效送风口, M型为无隔板型高效送风口, T型为有隔板型高效送风口  
 送风方式: 侧送风或顶送风  
 密封胶条: 进风面贴密封胶条  
 密封方式: 干式和液槽密封  
 耐温:  $\leq 90^{\circ}\text{C}$   
 测试口: PAO发尘口

Casing material: Cold-rolled steel which is treated by electrostatic spray.  
 Filter media: Ultra-fine fiberglass paper.  
 Diffuser panel: Air outlet panel material is aluminum plate, cold-rolled steel plate with electrostatic spray or stainless steel. L type is gel seal HEPA diffuser; M type is mini pleat HEPA diffuser; T type is separator HEPA diffuser.  
 Air supply mode: lateral inlet or top inlet.  
 Sealing gasket: Sealing gasket in air inletting side.  
 Sealing way: Gasket seal and gel seal.  
 Temperature: Maximum  $90^{\circ}\text{C}$  in continuous service.



# GEL SEAL / HEPA DIFFUSER

## HHD 液槽 / 高效送风口

### 产品介绍 Production Introduction

HHD 高效送风口是机械密封的高效送风口, 专门于洁净室高效送风口末端。过滤器与箱体之间的密封采用垫片密封, 采用EPDM密封条、凹凸密封条, 以及一体注塑无缝PU密封垫。密封垫与过滤器之间无任何粘接剂, 无透气不老化, 能够长久密封。

HHD 配备独立的PAO注入和扩散机构, 可方便地在室内进行PAO的注入和扩散, 对高效送风末端进行完整地检漏。

HHD 配备独立的HEPA压力测试装置, 可使操作人员方便地测试过滤器的压差。  
 出厂前每台箱体都要接受耐压测试, 确保零泄露。可根据需要安装箱体保温层。

HHD is a mechanical sealed high efficiency ceiling diffuser unit for clean-room application. The sealing mechanism between casing and filter is dry gasket sealing method. It adopts EPDM sealing strip, Concave-convex sealing strip and endless integrated PU sealing strip. There is no binder between sealing strip and filter, no air permeability and is not aging, it's able to seal for long time.

HHD has independent PAO injection / diffusion mechanism inside the plenum chamber, which allows indoor filter efficiency testing.

HHD has independent HEPA pressure testing connection device, enable operator test filter's differential pressure more convenient.

Each filter's housing will accept high-voltage insulation test in factory to ensure no leakage. We can install insulation for housing according to customer's request.

### 优势 Advantage

- 箱体采用优质冷轧钢板制成
- 表面静电喷塑
- 美观大方, 结构紧凑, 便于安装和维护
- 出风面散流面板为铝质喷塑、冷轧钢板喷塑或不锈钢
- Box casing is made of high-quality cold-rolled steel plate.
- Box surface is electrostatic spray.
- Elegant appearance with compact structure, convenience in installation and maintenance.
- The panel in air outlet can be made of aluminum plate or cold rolled steel plate coating or stainless steel.

### 应用 Application

- 用于生物制药、医疗卫生、医院实验室、空调和通风系统中高效过滤器的安装, 有效地确保气流速度和防止涡流。
- Suitable for installation of HEPA filter in biopharming, health and medical community, hospital laboratory, air-conditioning and ventilation systems. To ensure air flow speed and prevent swirl availablely.

### 常用规格 Common Specifications

型号 Model	额定风量 Rated Air Flow (m <sup>3</sup> /h)	可置HEPA规格 Mountable HEPA (mm)	箱体尺寸 Box Size (mm)		进风口尺寸 Air Supply Size (mm)		面板尺寸 Plate Size (mm)
			侧送风 Lateral Inlet	顶送风 Top Inlet	侧送风 Lateral Inlet	顶送风 Top Inlet	
HHD320/10-T	350	320×320×220	375×375×550	375×375×390	200×200	200×200	430×430
HHD484/10-T	1000	484×484×220	540×540×550	540×540×390	320×200	250×250	594×594
HHD484/15-T	1500	726×484×220	782×540×550	782×540×390	400×250	400×250	836×594
HHD484/20-T	2000	968×484×220	1024×540×550	1024×540×390	500×200	400×250	1078×594
HHD610/05-T	500	305×610×150	665×360×480	665×360×320	250×200	250×200	720×415
HHD610/10-T	1000	610×610×150	665×665×480	665×665×320	320×250	320×250	720×720
HHD610/15-T	1500	915×610×150	970×665×480	970×665×320	500×250	500×250	1025×720
HHD610/20-T	2000	1219×610×150	1275×665×480	1275×665×320	500×250	630×250	1330×720
HHD630/05-T	750	315×630×220	685×370×550	685×370×390	250×200	250×200	740×425
HHD630/10-T	1500	630×630×220	685×685×550	685×685×390	320×250	320×320	740×740
HHD630/15-T	2200	945×630×220	1000×685×550	1000×685×390	500×250	500×320	1055×740
HHD630/20-T	3000	1260×630×220	1315×685×550	1315×685×390	600×250	630×320	1370×740
HHD320/10-M	350	320×320×80	375×375×420	375×375×260	200×200	200×200	430×430
HHD484/10-M	800	484×484×80	540×540×420	540×540×260	320×200	320×200	594×594
HHD484/15-M	1200	726×484×80	782×540×420	782×540×260	400×200	400×200	836×594
HHD484/20-M	1700	968×484×80	1024×540×420	1024×540×260	400×250	500×200	1078×594
HHD610/10-M	1000	610×610×69	665×665×420	665×665×260	400×250	320×320	720×720
HHD610/15-M	1500	915×610×69	970×665×420	970×665×260	500×250	500×250	1025×720
HHD610/20-M	2000	1220×610×69	1275×665×420	1275×665×260	500×250	500×250	1330×720
HHD630/10-M	1500	630×630×80	685×685×420	685×685×260	400×250	320×320	740×740
HHD630/15-M	2150	945×630×80	1000×685×420	1000×685×260	500×250	500×250	1055×740
HHD630/20-M	3000	1260×630×80	1315×685×420	1315×685×260	600×250	630×250	1370×740
HHD320/10-L	350	320×320×93	375×375×420	375×375×260	200×200	200×200	430×430
HHD484/10-L	800	484×484×93	540×540×420	540×540×260	320×200	320×200	594×594
HHD484/15-L	1200	726×484×93	782×540×420	782×540×260	400×250	400×200	836×594
HHD484/20-L	1700	968×484×93	1024×540×420	1024×540×260	400×250	320×200	1078×594
HHD610/10-L	1000	610×610×93	665×665×420	665×665×260	320×250	320×250	720×720
HHD610/15-L	1500	915×610×93	970×665×420	970×665×260	500×250	200×200	1025×720
HHD610/20-L	2000	1220×610×93	1275×665×420	1275×665×260	500×250	320×250	1330×720
HHD630/10-L	1500	630×630×93	685×685×420	685×685×260	320×250	320×250	740×740
HHD630/15-L	2150	945×630×93	1000×685×420	1000×685×260	500×250	320×250	1055×740
HHD630/20-L	3000	1260×630×93	1315×685×420	1315×685×260	600×250	500×320	1370×740

注: 1、若遇规格、结构变更, 以本公司提供的最新数据为准; 有关更新内容请关注本公司网站: www.hefil.com

2、本公司接受非表上规格过滤产品的订货。

Note: 1. In case of specifications or structures changes, HEFIL will provide up-to-date data on website: www.hefilter.com.

2. HEFIL makes various of other models' HHD gel seal / hepa diffuser which are not listed in above table. Please consult with us if you need.

### 安装示意图 Installation Drawings

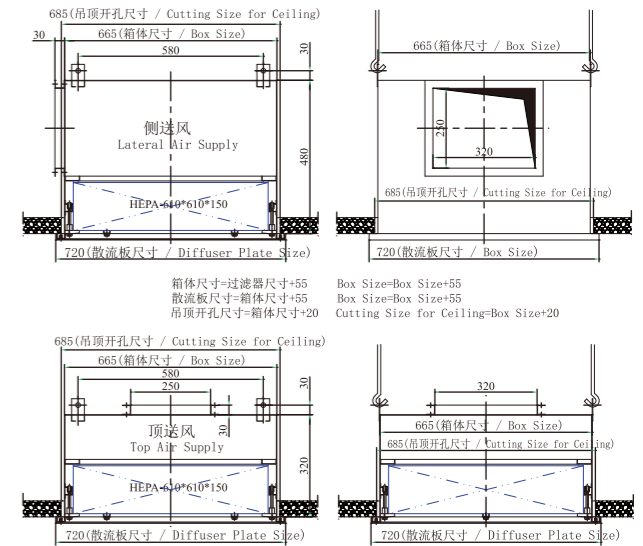

# FAN FILTER UNIT FFU 风机过滤单元

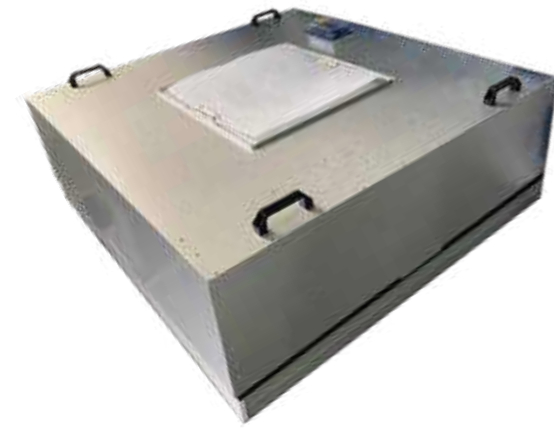

## 材质说明 Material Instructions

箱体材质: 镀铝锌板、不锈钢板、航空铝  
 强力风机: 国产电机或进口电机  
 过滤材料: 超细玻纤滤纸、PTFE膜  
 过滤效率: H13-U17  
 密封胶条: 双面贴密封胶条  
 耐温: ≤ 90°C

Casing material: Galvalume sheet, stainless steel or aviation aluminum.  
 Fan: Domestic motor or imported motor.  
 Filter material: Ultra-fine fiberglass or PTFE.  
 Filter efficiency: H13-U17.  
 Sealing gasket: Sealing gasket in double air supply sides.  
 Temperature: Maximum 90°C in continuous service.

# FAN FILTER UNIT FFU 风机过滤单元

## 产品介绍 Production Introduction

低耗能, 降低运行成本、低噪音、重量轻、易安装、智能型, 可选配交流或直流智能控制系统, 风速均匀, 特色流道使内部气流组织更合理。

It has low energy consumption and can reduce operating cost; it has low noise and light weight; it is convenient for installation; it is intelligent type and can be configured with DC / AC intelligent control system; the air speed is average, specialized passageway can obtain more reasonable internal air distribution.

## 优势 Advantage

- FFU风机过滤机组是由一台高性能AC交流风机、专业设计的箱体和HEPA / ULPA过滤器组成
- FFU箱体由镀铝锌板、不锈钢板或航空铝
- 采用强力风机, 可在高静压下长期使用, 同时又保持低噪音(≤50dB(A))
- 低噪音、功耗低、震动小、强度高、免维护
- 风速均匀、运行平稳、可无级调速
- 结构精巧坚固, 便于安装
- 三档调速控制或无级调速
- FFU consists of high performance AC fan, professionally designed box and HEPA / ULPA filter.
- Outer casing is made of galvalume sheet, stainless steel or aviation aluminum.
- Apply powerful fan, makes the whole equipment keep long-term operation under high static pressure and maintain a low noise (≤50dB(A)) at the same time.
- Low noise, low power consumption, small vibration, strong intensity, maintenance free.
- Uniform air speed, stable operation. In addition, continuously variability of air speed is available.
- Structure is compact and firm; Installation is easy and convenient.
- Three-speed control or continuously viable.

## 应用 Application

- 适合于10,000级到1级的各种洁净室, FFU系统方便灵活, 可以适用于任何结构和各等级的洁净室。它还可以用在其他净化设备上, 如: 可移动洁净房、洁净工作台、洁净走廊等。
- Suitable to a variety of clean rooms from Class 10,000 to Class 1, FFU system is convenient and flexible, can be applied to any structure and level of clean room. It can also be used to other cleaning devices, such as portable clean rooms, clean bench, clean corridors and so on.

## 常用规格 Common Specifications

型号 Model	模组尺寸 Dimensions (mm)	面风速 Face Velocity (m/s)		噪音 Noise (dB(A))		电源 Power Supply	功耗 Power Consumption (W)	机身重量 Host Weight (kg)	过滤器效率 HEPA Filter Efficiency	过滤器规格 HEPA Filter Specification (mm)	过滤器重量 HEPA Filter Weight (kg)	机外静压 External Static Pressure (Pa)
		低Low	高High	低Low	高High							
FFU-HA24	1175×575×320	0.35	0.55	≤46	≤52	AC, 1Φ-220V/50Hz	100~120	25	99.99~99.999%@0.3μm	1170×570×80/70	9.5	98
FFU-HA44	1175×1175×320	0.35	0.55	≤48	≤54		200~245	45		1170×1170×80/70	17	
FFU-HA22	575×575×320	0.35	0.55	≤46	≤52		75~90	15		570×570×80/70	5.2	

注: 1、若遇规格、结构变更, 以本公司提供的最新数据为准; 有关更新内容请关注本公司网站: www.hefil.com  
 2、本公司接受非表上规格过滤网产品的订货。

Note: 1. In case of specifications or structures changes, HEFIL will provide up-to-date data on website: www.hefilter.com.

2. HEFIL makes various of other models' FFU fan filter unit which are not listed in above table. Please consult with us if you need.

## 结构示意图 Structure Drawings

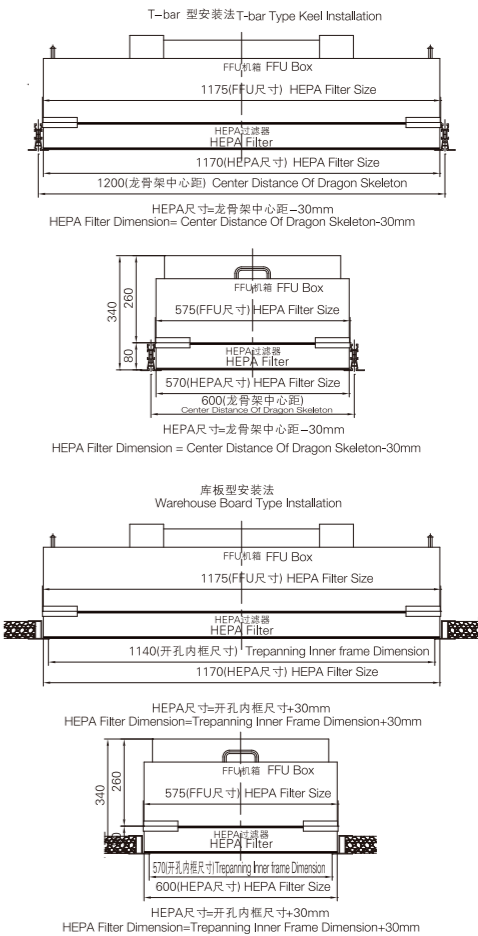

# EXPLOSION-PROOF LOWER DETACHABLE FAN FILTER UNIT 防爆下拆式风机过滤单元

## 产品介绍 Production Introduction

防爆下拆式FFU又称为液槽密封式FFU或者下拆式高效过滤器FFU，防爆下拆式FFU是根据部分药厂GMP洁净厂房的严格要求而特别研发的一种新型FFU，其FFU风机和高效过滤器是可分离式的，工作原理和普通FFU一样，风机从顶部将空气吸入，并经高效过滤器过滤后将洁净空气均匀送出，为洁净环境提供洁净空气和微粒过滤控制。

It is a new type of FFU specially developed according to the strict requirements of GMP clean plant in some pharmaceutical factories. Its FFU fan and high efficiency filter are separable, and the working principle is the same as ordinary FFU, the fan draws in the air from the top, and after filtering by high efficiency filter, the clean air will be evenly reached out, providing clean air and particle filtration control for clean environment.



## 材质说明 Material Instructions

风量: 600m<sup>3</sup>/h, 1100m<sup>3</sup>/h, 2200m<sup>3</sup>/h  
 风速: 0.45m/S ± 20%  
 洁净度: 100级 (美国联邦标准209E)  
 HEPA效率: 99.99% @ 0.3 μm  
 噪声: 53dB  
 壳体材质: 不锈钢, 覆铝锌板, 钢板喷塑  
 电源: 220V, 50Hz  
 Air volume: 600m<sup>3</sup>/h, 1100m<sup>3</sup>/h, 2200m<sup>3</sup>/h  
 Wind speed: 0.45m/S ± 20%  
 Cleanliness: Class 100 (US Federal Standard 209E)  
 HEPA efficiency: 99.99% @ 0.3 μm  
 Noise: 53dB  
 Shell material: stainless steel, aluminum zinc coated plate, steel plate spraying  
 Power supply: 220V, 50Hz

# EXPLOSION-PROOF LOWER DETACHABLE FAN FILTER UNIT 防爆下拆式风机过滤单元



## 优势 Advantage

- 底部采用固定件特殊设计，装拆及更换过滤器时单人操作、方便快捷
- 采用高效交流离心风机，过热保护能力好，有效降低损耗
- 风速平稳、使用寿命长。适合于洁净度Class1-1000级无尘室
- 特别适合于组装成超净生产线，可根据工艺需要布置为单台使用，也可将多台串联形成100级流水装配线
- 轻量化，薄型化机体，更方便在小区域应用
- The bottom is specially designed with fixed parts, which is convenient for single person operation when installing and removing and replacing filters.
- Adopt high-efficiency AC centrifugal fan, with good overheating protection ability and effective reduction of loss
- The air speed is stable and the service life is long. Suitable for cleanliness Class1-1000 clean room
- Especially suitable for assembling into ultra-clean production line, which can be arranged as a single unit according to process needs, or multiple units can be connected in series to form a Class 100 assembly line
- Lightweight, thin body, more convenient for small area applications

## 应用 Application

- 防爆下拆式FFU风机滤网机组可模块化连接使用，使用FFU广泛应用于洁净室、洁净工作台、洁净生产线、组装式洁净室和局部百级等应用场合。
- The lower detachable FFU fan filter units can be modularly connected and used in clean rooms, clean benches, clean production lines, assembled clean rooms and partial class 100 applications.

## 常用规格 Common Specifications

型号样式 Model Style	规格 Specification	实际出风量 Output air volume	功率 Power	噪音 Noise	电压 Voltage
超薄FFU	1175*575*110	1000	170W	≤58dB	220V
FFU117	1175*575*320	1000	120W	≤58dB	220V
FFU615	615*615*320	700	100W	≤58dB	220V
FFU915	915*615*320	900	100W	≤58dB	220V
FFU1175	1175*1175*350	2160	180W	≤60dB	220V

注: 1. 若遇规格、结构变更, 以本公司提供的最新数据为准; 有关更新内容请关注本公司网站: www.hefil.com  
 2. 本公司接受非表上规格过滤网产品的订货。  
 Note: 1. In case of specifications or structures changes, HEFIL will provide up-to-date data on website: www.hefilter.com.  
 2. HEFIL makes various of other models' HRU replaced hepa box which are not listed in above table. Please consult with us if you need.

## 结构示意图 Structure Drawings

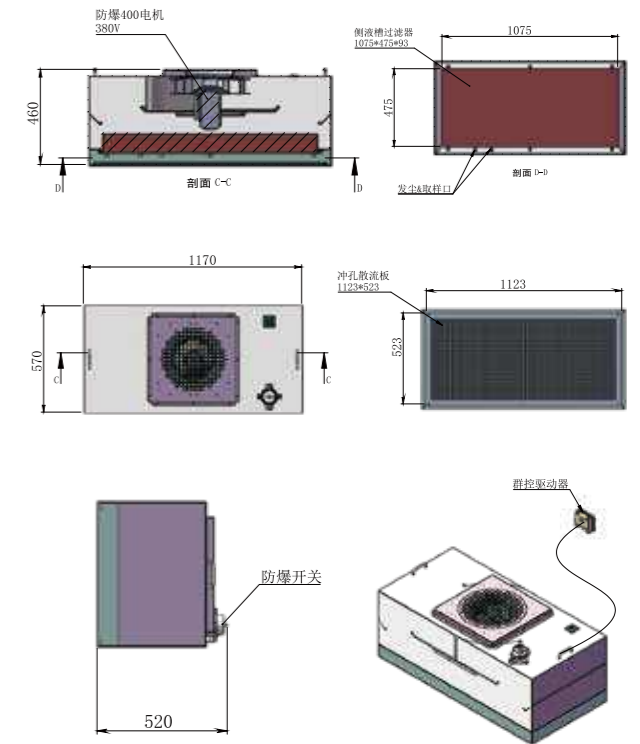

# EQUIPMENT FAN-FILTER UNIT

## EFU 超薄设备风机过滤单元

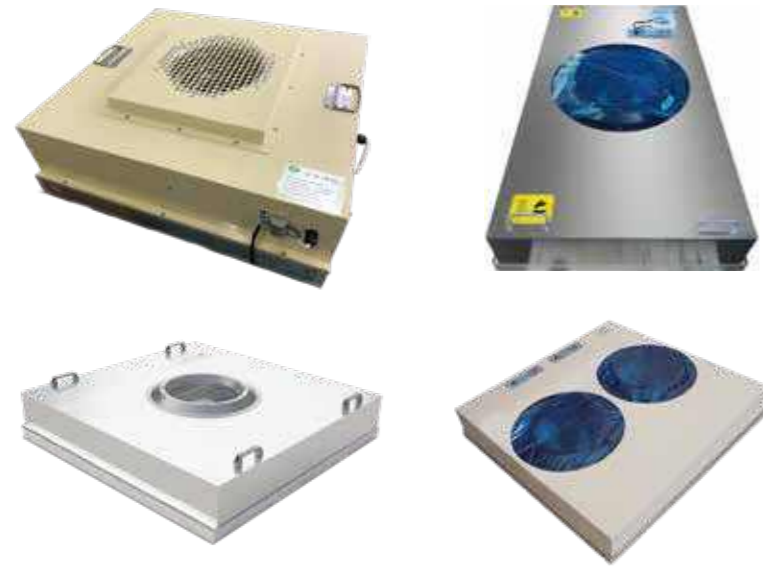

### 材质说明 Material Instructions

箱体材质: 镀铝锌板、不锈钢板、铝合金板  
 强力风机: 国产电机或进口电机  
 过滤材料: 超细玻璃纤维纸  
 过滤效率: H13-U17  
 密封胶条: 双面贴密封胶条  
 耐温: ≤ 90°C

Casing material: Galvalume sheet, stainless steel or aviation aluminum.  
 Fan: Domestic motor or imported motor.  
 Filter material: Ultra-fine fiberglass filter paper.  
 Filter efficiency: H13-U17.  
 Sealing gasket: Sealing gasket in double air supply sides.  
 Temperature: Maximum 90°C in continuous service.

# EQUIPMENT FAN-FILTER UNIT

## EFU 超薄设备风机过滤单元

### 产品介绍 Production Introduction

低耗能, 降低运行成本、低噪音、重量轻、易安装、智能型, 可选配交流或直流智能控制系统, 风速均匀, 特色流道使内部气流组织更合理。

It has low energy consumption and can reduce operating cost; it has low noise and light weight; it is convenient for installation; it is intelligent type, and can be configured with DC / AC intelligent control system; its air speed is average, specialized passageway can obtain more reasonable internal air distribution.

### 优势 Advantage

- ◆ EFU 风机过滤机组是由一台高性能风机、专业设计的箱体和HEPA / ULPA 过滤器组成
- ◆ 超薄型EFU箱体厚度可低至110mm, 箱体由镀铝锌板、不锈钢板或铝合金板制成
- ◆ 采用强力风机, 可在高静压下长期使用, 同时又保持低噪音(≤50dB(A))
- ◆ 根据不同的工况, 可以选择多款先进的EC / DC / AC风机, 以满足不同工况下风量与总压的要求, 并采用与风机相适应的控制模式, 以达到工况需求、机组配制、控制方式三者的最佳匹配
- ◆ 对于不同的风机, 可以实现简捷、实用的现场手动控制; 并针对大规模的控制, 可以提供Elisa电子控制系统, 实现网络集中控制
- ◆ 整个机组均选用极低挥发物的原材料制成, 不会对用户现场产生其他异常气体; 另外如对气态分子污染物控制有额外需求, 也可选配PTFE 过滤器或者化学过滤器
- ◆ 运行平稳、功耗低 (运行成本低)、强度高 (工作时长)、低噪声、免维护、震动小、风速均匀、应用范围广
- ◆ 结构精巧坚固, 便于安装
- ◆ 五档调速或无级调速

- ◆ EFU consists of high performance fan, professionally designed box and HEPA / ULPA filter.
- ◆ The thickness of ultra-thin EFU box can be as thin as 110 mm, outer casing is made of galvalume sheet, stainless steel or aluminum alloy sheet.
- ◆ Apply powerful fan, makes the whole equipment keep long-term operation under high static pressure and maintain a low noise (≤50dB(A)) at the same time.
- ◆ Considering different working conditions, several kinds of advanced fans are available, EC / DC / AC, will meet the requirements of air flow and total pressure under different working conditions. The control mode is specially designed for fan, thus meeting the perfect matching of working condition, unit configuration and control mode.
- ◆ For different kinds of fans, simple and practical manual control can be realized on the scene; Aiming at the large scale control, Elisa Electronic Control system will be supplied to meet the Network Centralized Control.
- ◆ The entire unit are made from extremely low volatile material, which will not produce strange gases for customer's site; In addition, if there is additional requirements of the controlling of gaseous molecular contaminants, PTFE filter or chemical filter is optional.
- ◆ Stable operation, low power consumption (low running costs), strong intensity (long service time), low noise, maintenance free, small vibration, uniform velocity, wide range of applications.
- ◆ Structure is compact and firm; installation is easy and convenient.
- ◆ Five-speed or continuously viable.

### 结构示意图 Structure Drawings

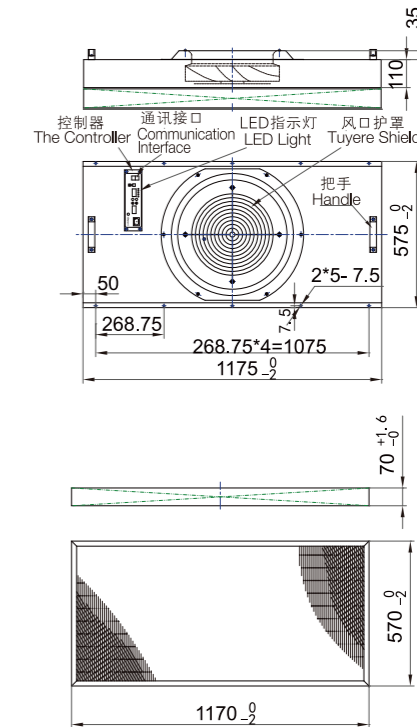

### 应用 Application

- ◆ 适合于10,000级到1级的各种洁净室, FFU系统方便灵活, 可以适用于任何结构和各等级的洁净室。它还可以用在其他净化设备上, 如: 可移动洁净房、洁净工作台、洁净走廊等。
- ◆ Suitable to a variety of clean rooms from Class 10,000 to Class 1. FFU system is convenient and flexible, can be applied to any structure and level of clean room. It can also be used to other cleaning devices, such as: portable clean room, clean bench, clean corridors and so on.

### 常用规格 Common Specifications

型号 Model	模组尺寸 Dimensions (mm)	面风速 Face Velocity (m/s)		噪音 Noise (dB(A))		电源 Power Supply	功耗 Power Consumption (W)	机身重量 Host Weight (kg)	过滤器效率 HEPA Filter Efficiency	过滤器规格 HEPA Filter Specification (mm)	过滤器重量 HEPA Filter Weight (kg)	机外静压 External Static Pressure (Pa)
		低Low	高High	低Low	高High							
EFU-HA24	1175x575x(110/160+35)	0.35	0.55	<46	<52	AC, 1Φ-220V/50Hz	100~120	25	99.99~99.9999%@0.3μm	1170x570x80/70/50	9.5	98
EFU-HA44	1175x1175x(160+35)	0.35	0.55	<48	<54		200~245	45		1170x1170x80/70/50	17	
EFU-HA22	575x575x(130/160+25)	0.35	0.55	<46	<52		75~90	15		570x570x80/70/50	5.2	

注: 1、若遇规格、结构变更, 以本公司提供的最新数据为准; 有关更新内容请关注本公司网站: www.hefil.com  
 2、本公司接受非表上规格过滤网产品的订货。

Note: 1. In case of specifications or structures changes, HEFIL will provide up-to-date data on website: www.hefilter.com.

2. HEFIL makes various of other models' EFU equipment fan-filter unit which are not listed in above table. Please consult with us if you need.



# NEGATIVE PRESSURE WEIGHING BOOTH, SAMPLING BOOTH

## HNP 负压称量罩、取样罩



### 材质说明 Material Instructions

箱体材质: 镀锌锌板、不锈钢板、铝合金板  
 强力风机: 国产电机或进口电机  
 过滤材料: 超细纤维滤纸  
 过滤效率: H13-U17  
 密封胶条: 双面贴密封胶条  
 耐温: ≤ 90°C

Casing material: Galvalume sheet, stainless steel or aviation aluminum.  
 Fan: Domestic motor or imported motor.  
 Filter material: Ultra-fine fiberglass or PTFE.  
 Filter efficiency: H13-U17.  
 Sealing gasket: Sealing gasket in double air supply sides.  
 Temperature: Maximum 90°C in continuous service.

# NEGATIVE PRESSURE WEIGHING BOOTH, SAMPLING BOOTH

## HNP 负压称量罩、取样罩

### 产品介绍 Production Introduction

是一种提高局部环境洁净度等级、采用顶送风单向层流的空气净化设备。在生物医药、食品及化妆品等行业，类似于称量、研磨、分发等操作程序会产生粉末颗粒影响洁净环境，这些粉末颗粒往往是有毒、有害或者是过敏性的，因此负压称量罩、取样罩系统能有效的把操作人员和邻近的工作区域进行安全隔离保护。称量区动态百级垂直层流A级 (ISO 5,百级)，按照FDA和欧盟GMP以及中国GMP的要求进行设计。

HNP is a kind of air clean equipment improving local environment cleanliness level, using top air supply unidirectional laminar flow. In bio-pharma, food, cosmetic and other industries, procedures similar to weighing, grinding, distribution and others will produce powder particles which affect the clean environment. The powder particles tend to be poisonous, harmful, or anaphylactic, so the Ultraboath WB system can effectively separate the operators and adjacent work area for safety protection purpose.

Weighing area is dynamic vertical laminar class A (ISO 5, hundred grades), carry on the design according to requirement of the FDA, the European GMP and Chinese GMP.

### 优势 Advantage

- ◆ 风速侦测自动变频系统使层流区风速始终处于匀速平稳运动状态。
- ◆ 智能化PLC控制模式和故障报警系统有效保证机器运行的可靠性。
- ◆ 初、中、高效过滤器均有压差显示装置实时监控各过滤器的有效进行。
- ◆ 层流工作区采用独特的均流膜设计使单向层流更加均匀。均流膜还具有高透光性的特点。照明系统采用内置式LED灯。
- ◆ 个性化的设计使初、中效过滤器更换方便可靠。机器箱体采用优质304不锈钢。
- ◆ Velocity detection automatic frequency conversion system, make the laminar flow velocity is always in a state of steady motion at a constant speed
- ◆ Intelligent PLC control mode and fault alarm system, effectively guarantee the reliability of the machine running
- ◆ Pre, medium and high efficiency filters have pressure difference display device, real-time monitor of each filter running effectively
- ◆ Laminar workspace adopts unique design of flow membrane which makes a one-way laminar flow more evenly. Flow membrane also has the characteristics of high transmission of light. Using built-in tears clean lamp for lighting system.
- ◆ Machine body is made of high quality 304 stainless steel. Personalized design, make pre, medium efficiency filter replacement is convenient and reliable .

### 工作原理 Working principle

- ◆ 称量室是一种用于制药、微生物研究和科学实验等场所专用的局部净化设备，它提供一种垂直单向气流，部分洁净空气在工作区循环，部分排出至附近区域，使工作区产生负压，防止交叉污染，用于保证工作区的高洁净度环境。
- ◆ 在设备中进行粉尘、试剂的称量和分装，用以控制粉尘、试剂外溢、上扬、防止粉尘、试剂对人体的吸入危害，还避免粉尘、试剂与外界交叉污染，保护外界环境及室内人员的安全。
- ◆ Weighing chamber is a kind of partial purification equipment specially used for pharmacy, microbial research and scientific experiments and so on, it provides a vertical unidirectional airflow. Part of the clean air circulate the workspace, part discharge to the area, make the workspace to produce negative pressure to prevent cross contamination, is used to ensure cleanliness of a high cleanliness work environment
- ◆ Implement weighing and packing of dust, reagents in the equipment, in order to control dust, reagent spillover, rise, prevent inhaled a harm of dust, reagents to human body, also avoid cross-contamination between dust, reagent and the outside world, to protect the environment and the indoor personnel safety.

### 应用 Application

- ◆ 在原料的称重、采样、灌装和分装或提纯过程中使用。
- ◆ It is used in weighing, sampling, filling and sub filling or purification of raw materials.

### 配置表 Configuration Sheet

组件名称 Component Name	配置 Configuration	进口 Imported	国产 Domestic
风机 Fan	双进风低噪音离心风机 无蜗壳风机 The double inlet low noise centrifugal fan Fan without volute casing	● ○	○ ●
过滤器 Filter (预过滤) (pre filtration) (中效过滤) (medium efficiency filtration) (高效过滤) (HEPA filtration)	板式初效过滤器 板式或袋式过滤器 大风量H13过滤器 或液槽过滤器H14 Plate type pre-filter Plate or bag type filter Large airflow filter H13 or gel seal filter H14	● ● ●	○ ○ ○
均流 Uniform Flow	均流膜 Uniform flow membrane	●	○
电器部件 Electrical Component	变频器 Frequency converter 电气箱 Electrical Cabinet 防水电源插座 Waterproof electrical outlet 防水电源开关 Waterproof power switch 急停按钮 Scram button LED灯 LED light Tears light	● ○ ● ● ● ○	○ ○ ○ ○ ○
电控部件 Electronic Control Parts	PLC控制器 PLC controller 触摸屏 Touch screen 传感器 Sensor	● ● ●	○ ○
压力监测 Pressure Monitoring	压力表 Pressure gage	●	
箱体材质 Casing Material	304 不锈钢 304 SS	●	○

备注: ● 标配 ○ 选配  
 Mark: ● Standard ○ Optional

### 常用规格 Common Specifications

型号 Model	工作区层流面积 (m²) Laminar Flow Area of the Workspace	工作区层流风速 (m/s) Laminar Flow Velocity of the Workspace	额定风量 (CHM) Rated Air Flow	高效过滤效率 Hepa Filter Efficiency	高效过滤工作区尺寸 长×宽×高 (mm) Workspace Size	外形尺寸 长×宽×高 (mm) Dimension	额定功耗 (含插座容量) (KW) Rated Power Consumption	噪声 (A) Noise dB	照明 Lighting	电源 Power Supply
HNP 5	5	≤ 0.45±20%	7000	≥ 99.99% (@ ≥ 0.3um)	2000x2200x1850	2100x3200x2600	≤ 4	≤ 75	> 300Lx 220V 50Hz	AC 380V 50Hz
HNP 3	-		5000		1800x1600x1850	1900x2600x2600	≤ 3	≤ 72		
HNP 2	-		3000		1300x1600x1850	1400x2600x2600	≤ 2	≤ 65		

注: 1、若遇规格、结构变更, 以本公司提供的最新数据为准; 有关更新内容请关注本公司网站: www.hefil.com  
 2、本公司接受非表上规格过滤网产品的订货。

Note: 1. In case of specifications or structures changes, HEFIL will provide up-to-date data on website: www.hefilter.com.

2. HEFIL makes various of other models' HNP negative pressure weighing booth, sampling booth which are not listed in above table. Please consult with us if you need.

# CLEAN LAMINAR BOOTH

## HLB 洁净层流罩



### 材质说明 Material Instructions

箱体材质: 壁板、喷塑冷轧钢板或全不锈钢  
 风机: 专用离心风机  
 过滤系统: 采用板式初效过滤器、无隔板高效过滤器, 组合效率可达99.99%@0.3um

Casing material: Sandwich panel, cold-rolled steel or stainless steel sheet.  
 Casing material: Cold-rolled steel or stainless steel sheet  
 Fan: Specialized centrifugal fan.  
 Filtration system: Consists of high-quality primary-efficiency panel filter and mini-pleat HEPA panel filter, overall efficiency reaches 99.99%@0.3um.

# CLEAN LAMINAR BOOTH

## HLB 洁净层流罩

### 产品介绍 Production Introduction

百级单向层流罩系统是一种把较低的洁净环境创造出局部高洁净度环境的设备, 可使该局部环境的洁净度达到ISO 5级。该产品广泛应用于生物医药、食品、电子等行业, 需要提高局部环境的洁净度, 使其达到高级别洁净环境要求的领域。

The hundred grade one-way laminar flow hood system is the equipment which can create a local environment with high cleanliness under the low clean environment. It can make the cleanliness of the local environment to ISO5 class. The products are widely used in biological medicine, food, electronic industries, need to improve the cleanliness of local environment, make it meet the requirements of high grade clean environment.

### 优势 Advantage

- ◆ 灵活地吊装于需要高洁净度的工艺点上方, 以满足局部高洁净度的要求
- ◆ 箱体可由壁板、喷塑冷轧钢板或全不锈钢制成
- ◆ 大风量双速高压风机, 具有体积小、风量大、高压、低噪音等特点
- ◆ 优质板式初效过滤器、无隔板高效过滤器组合
- ◆ 可单独使用, 也可多个并联组成洁净层流带
- ◆ 安装方式: 悬吊或支架支撑方式
- ◆ 投资省、见效快、安装简便、运行费用低
- ◆ 洁净度: ISO Class 5 / FS209E 100级 ( $\geq 0.5\mu\text{m}$ 尘埃数 $\leq 3.5$ 颗/升)
- ◆ 平均风速0.35~0.55m/s
- ◆ 噪声 $\leq 64\text{dB(A)}$

- ◆ Can be lifted over the process point that requires high cleanliness to meet the requirements of local high level cleanliness.
- ◆ Outer casing can be made of cold-rolled steel or stainless steel sheet.
- ◆ Use double-speed and high pressure fan, which is with the feature of small size, large air volume, high pressure, low noise etc.
- ◆ It consists of high-quality primary-efficiency panel filter and mini-pleat HEPA panel filter.
- ◆ Can be used alone or can be composed into multiple parallel and work as clean laminar flow zoon.
- ◆ Installation mode: Suspension or brace.
- ◆ Less investment, faster effect, easy to installation and low operating costs.
- ◆ Cleanliness: ISO Class 5 / FS209E Class 100 ( $\geq 0.5\mu\text{m}$  dust particles  $\leq 3.5$  A/l).
- ◆ Air velocity: 0.35~0.55m/s.
- ◆ Noise:  $\leq 64\text{dB(A)}$ .

### 应用 Application

- ◆ 主要用于生物制药、医疗卫生、医院实验室、电子、食品、精密仪器等行业的无尘无菌操作环境, 提供局部高洁净度工作环境。
- ◆ Mainly used to clean and sterile operating environment of biopharming, health and medical community, hospital laboratory, electronics, food, precision instruments, provide high level cleanliness of the working environment.

### 结构示意图 Structure Drawings

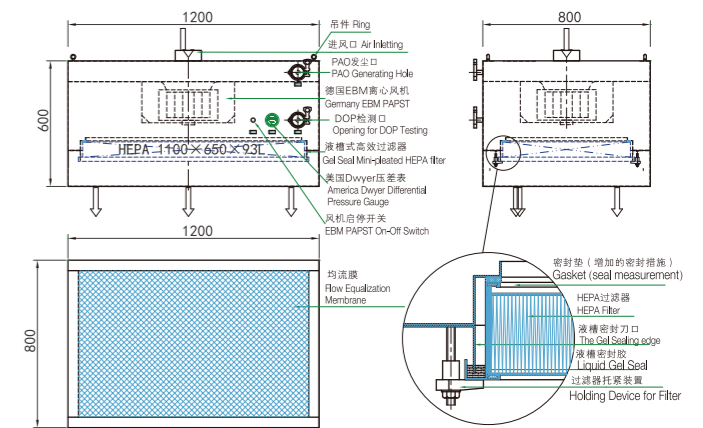

### 工作原理 Working principle

- ◆ 百级单向层流罩系统是通过风机动力将需要提高洁净度区域内的空气, 以一定速度通过高效过滤器或超高效过滤器后, 再经均流膜或不锈钢均流孔板进行均压均流, 使洁净空气流呈垂直单向流流向工作区, 配合周围护板或PVC垂帘, 从而保证了工作区达到ISO 5级的洁净空间。
- ◆ The hundred grade one-way laminar flow hood system is clean space that send air whose cleanliness need to be improved by the fan power at a certain speed through the HEPA filter or ultra high efficiency filter, then through uniform flow membrane or stainless steel pore plate to make uniform pressure and flow, send the clean air flow in vertical one-way to the workspace with guard plate around or PVC curtain, thus ensuring the workspace to class ISO 5.

### 常用规格 Common Specifications

型号 Model	额定风量 Rated Air Flow (m³/h)	外形尺寸 Dimension LxWxH (mm)	工作区尺寸 Working Area Dimension (mm)	HEPA规格 HEPA Specification	电源 Power Supply and Dissipation
HLB 1220/610	1200	1360x740x850	1220x610	610x610x150 (mm) 2pcs	AC 1Φ-220V/50Hz
HLB 1220/915	1800	1360x1040x850	1220x915	915x610x150 (mm) 2pcs	
HLB 1220/1220	2400	1360x1360x850	1220x1220	1219x610x150 (mm) 2pcs	
HLB 2500/915	4800	3200x1040x600	2500x915	915x610x150 (mm) 4pcs	AC 3Φ-380V/50Hz

注: 1、若遇规格、结构变更, 以本公司提供的最新数据为准; 有关更新内容请关注本公司网站: www.hefil.com

2、本公司接受非表上规格过滤网产品的订货。

Note: 1. In case of specifications or structures changes, HEFIL will provide up-to-date data on website: www.hefilter.com.

2. HEFIL makes various of other models' HLB clean laminar booth which are not listed in above table. Please consult with us if you need.

# BAG-IN / BAG-OUT FILTER HOUSING

## HBIBO 袋进袋出过滤装置



### BIBO袋进袋出过滤器更换袋子

1. 该膜材料主要原材料为聚乙烯材料，具有耐腐蚀和抗拉性强抗

2. 采用黄底或白底半透0.2mmPVC环保薄膜制作而成，袋口配有M8花式松紧带或者黑色O型圈包裹而成，该材料柔软抗拉性强。

广泛应用于各种高危险性或高隔离要求的领域，例如：化学生物(CB)防护、化学、生物及放射(CBR)防护、核化、生物及化学(NBC)防护、医院隔离病房、制药设备、微电子环境、食品加工区域、生物研究、遗传与生物技术实验室、工业处理排放系统、化工处理设备、动物疾病研究实验室、放射性同位素处理设备、核电站、战略核设施、D.O.E设备、军事基地等。



# BAG-IN / BAG-OUT FILTER HOUSING

## HBIBO 袋进袋出过滤装置

### 产品介绍 Production Introduction

采用全封闭袋进袋出式更换过滤器的方式，能有效隔离放射性气体、病原体以及有毒化学品的污染，故也称作袋进袋出安全防护过滤箱。为用户提供安全可靠的环境，有效防止空气二次污染，并确保操作人员的安全。

该装置用于滤除空气中有害的化学、生物、放射性、毒性等物质，通过该系统把污染物封闭在BIBO箱体的过滤器内，直至过滤器被更换并焚烧处理。

该装置可根据具体的应用设计制造，可包含多个功能段和组合模块，满足不同等级、不同风量的要求，主要功能段包括过滤段（初、中、高效过滤）、扫描测试段、化学过滤段、气溶胶注入、压差检测、消毒等；并联/串联组装，以增加装置的风量和功能段。

HBIBO used all closed bag into bag out replacement filtration device can effectively isolate radgas, pathogens, and toxic chemical's pollution, so it's called bag into bag out safety protection filtration box; which used to provide safe and reliable environment, effectively prevent secondary air pollution and ensure the safety of operators;

The device is used for filtering harmful chemical, biological, radioactive, toxic substances in the air, to close the pollutants in HBIBO box filter through the system, until the filter was replaced and incineration.

HBIBO can be designed and manufactured according to the specific application, can contain more than one function and combination module to meet the requirements of different levels, different air volume, the main features include filtering period (Pre, middle and high efficiency filter), scanning test period, chemical filtration, aerosol injection, differential pressure detection, biological sealed valve, disinfection, and tandem assembly, in order to increase the air flow and function of HBIBO.

### 集气管 (进口或不益生产)

箱体进出风接口与上、下游风管之间通过密闭阀相连，根据客户要求提供多叶阀或生物密闭阀；

箱体板材采用激光切割、数控折弯进行加工，确保加工精度，箱体采用自动焊接机器人进行连续无缝焊接，箱体一次成型，较大限度保障箱体的气密性；

箱体表面选用碳钢环氧树脂喷涂，涂层具有耐甲醛、过氧化氢(VHP)等消毒剂腐蚀的特性，可选配氟碳喷涂；

箱体材质采用SUS304 不锈钢；

### 过滤段

核心部分是具有袋进袋出功能的过滤段，过滤器与袋进袋出箱体之间的密封可采用垫片密封或液槽密封；

模块化设计，根据使用系统的风量不同进行并联组合，可从风量1000CMH到40000CMH进行选择，可以满足客户对送风和排风量不同的要求。同时，根据客户对不同功能段进行串联组合，能够满足安装空间的要求；

通过工厂气密性耐压测试，在正压2500Pa或负压3000Pa条件下，符合ASME N510-1989气密性测试标准；整套设备的制造和测试应分别符合ASME N-510标准和GB19489-2008标注；

过滤器压紧机构（已申请专利），压紧装置的压紧行程大，过滤器边框接触面受力均匀，采用可靠的过滤器锁紧机构加强密封效果，安装过滤器方便。

### 生物密闭阀 (选配) (进口或不益生产)

生物密闭阀是用于高度危险排风系统，用于关断和隔离过滤器与周边环境。

气密阀门是风阀产品线中最高级别的产品，用于过滤器更换过程中的隔离用，特别是针对大风量空气系统的有效隔离；

阀门通常做成圆形，可以配置电动和气动执行器；

阀门叶片是在关闭位置，10英寸水柱压力下检测的，符合ASME N509-1996"Reaffirmed"第5.9.7.3的规定。阀门整体压力检测符合ASME N510-1995"Reaffirmed"，"Testing of Nuclear Air Treatment Systems"第6 和第7 条的规定。

### 空气过滤器

配套HBIBO的高效过滤器效率选用H14级，过滤效率为99.995%@MPPS，外框架为镀锌铝材质，可选配SUS430 / SUS 304；高效过滤器的密封方式采用干式垫片密封或液槽密封。

单级过滤 (H13或H14)，多级过滤 (G4+H13或M6+H14) 或排风系统中多级过滤 (G4+F8+H14+H14) ；

单个HBIBO过滤器模块的较大风量可达到4000CMH。

### 塑料袋

塑料袋用于避免更换维护人员在更换过滤器时接触过滤器，采用特殊设计的塑料袋用以更换过滤器，这就称为袋进袋出生物安全更换；

塑料袋具有强度高，不易破损的特性；橡胶环为特殊专利设计形状，锁紧塑料袋的效果好。

### Gas Collecting Tube (imported or manufacture by HEFIL)

● Housing is connected by sealed valve between inlet / outlet connector and upstream/downstream pipe, provides the leafy or biological containment valves according to the customer request;

● Housing adopts laser cutting, CNC bending process to ensure the machining accuracy. Housing adopts automatic welding robot to do continuous seamless welding and a molding box, ensure maximum air impermeability of housing;

● Housing surface choose carbon steel epoxy resin coating, surface coating has excellent feature of corrosion proof for formaldehyde, hydrogen peroxide (VHP) and other disinfectants, can choose fluorine carbon spraying;

● Housing material can choose painting carbon steel and SUS304 stainless steel;

### Filtering Section

● Core part is filtering section with bag in bag out function, sealing of the housing between the filter and bag in bag out can use gasket seal or flume seal;

● Modular design, parallel combination according to different air volume, can choose air volume from 1000 CMH and 50000 CMH, can meet customer's different requirements for air supply and exhaust air volume. At the same time, series combination of different function units according to the customer, can meet the requirements of the installation space;

● Past plant air tightness test in positive pressure 2500 pa or negative pressure 3000 pa condition, conform to the ASME N510-1989 air tightness test standard; manufacturing and testing of the whole equipment should conform ASME N510 or GB19489-2008 standard;

● Unique filter pressure institution (has applied for patent), the compression stroke of clamping device is big, filter frame contact force is uniform, adopt reliable filter locking mechanism to strengthen the sealing effect. Easy to install filter, and can support heavy filter.

### Bio-sealed Valves (Optional) (imported or manufacture by HEFIL)

● Bio-sealed valves are used for highly dangerous exhaust system, used to shut off and isolate the filter and the surrounding environment

● Bubble-tight valve is the highest level product of the air valve product line, used for the isolation in the process of filter replacement, especially for effective isolation of large volume air system;

● Valve is usually made round, you can configure manual, electric and pneumatic actuators;

● Valve blade is in the shutoff position, test under 10 inches water column pressure, comply with the ASME N509-1996 "Reaffirmed" 5.9, 7.3. Valve integral pressure Testing in accordance with ASME N510-1995 "Reaffirmed", "Testing of Nuclear Air Treatment Systems," the provisions of article 6 and 7.

### Air Filter

● HEPA filter supporting BIBO use efficiency of H14, filter efficiency is 99.999% @0.3μm, the material of outside frame is galvalume, SUS430 / SUS304 optional; HEPA filter uses gasket seal or flume seal.

● Single-stage filtering (H13 or H14), Multistage filtering (G4+H13 or M6+H14) or multistage filtering in exhaust system (G4+F8 +H14+H14)

● A single filter module maximum air volume can reach 4000 CMH

### Plastic Bag

● Plastic bags are used to avoid the replace maintenance personnel contacting filter in the replacement of filter, use special designed plastic bags to replace filter, this is called a bag in bag out biological security replacement;

● Plastic bags have high strength, unbreakable character; rubber ring has special patented design shape, locking plastic bag with good effect.

# BAG-IN / BAG-OUT FILTER HOUSING

## HBIBO 袋进袋出过滤装置



### 压力检测机构

袋进袋出的每级过滤器均设有压力检测机构，为了检测过滤器的阻力，配有压力表、仪表架、连接器、连接管路等，可选配压差变送器将信号传至中控系统；

压力检测机构的测压管路带有气密隔离阀，压力表上下游管路内设有高效过滤器和消毒口，能对上下游管路内部进行消毒；测压管和相关配件为SUS 304 不锈钢；（选配）

### 原位消毒

在过滤器的上下游位置配置气体消毒接口，可与国际通行的标准消毒设备接驳，通过消毒接口可以注入甲醛（福尔马林）或过氧化氢(VHP) 等气态消毒产品。

袋进袋出本身设有不锈钢球阀，可以方便的注入消毒产品，使其在过滤器表面充分扩散，消毒任何部位。

可以通过过滤器上游的检测采样口检测消毒产品的浓度是否符合消毒规范的要求，通过下游的消毒验证口，检验消毒的效果。

### 检漏装置

高效过滤器在出厂前均经过严格的检漏测试及过滤效率测试以确保过滤器的过滤效率符合客户要求；（H13 或H14）；

检测用气溶胶的通中直径为0.3um，气溶胶的发生浓度和粒径分布均匀和稳定，可采用DEHS、PAO 等物质；

在每级高效过滤器之后，可选配手动或自动扫描系统，对过滤器进行检漏，扫描装置在工作状态下对过滤器进行效率检测，来检测过滤器是否泄漏；按照GB19489-2008标准对过滤器进行检漏；

### 风机

根据客户的要求配置风机段，可提供变频电机控制，达到节能目的；

德国Rosenberg无蜗壳风机，直联马达驱动，避免由于皮带传动产生的皮带灰层，减少袋进袋出自身的产生尘；具有高效率、低噪音、性能稳定和容易清洁的特性；

科洛格风机，瑞士品牌；通过“AMCA”认证，通过严格的动平衡测试，免维护球型轴承，强度高，噪声低，性能稳定。

### Pressure Testing Organizations

● Per level filters of bag in bag out have pressure testing organizations in order to test the resistance of the filter, equipped with a pressure gauge, meter support, connector, connecting piping, etc., can be equipped with differential pressure transmitter to transmit the signals to the control system.

● Piezometric tube of pressure testing organization has airtight isolation valve, pressure gauge upstream and downstream piping has internal HEPA filters and disinfection mouth to disinfect upstream and downstream piping interior. Piezometric tube and related accessories are SUS 304 stainless steel (optional).

### In Situ Disinfection

● Equip gas disinfection interface in the place of upstream and downstream of the filter, same as disinfection equipment with internationally accepted standards, through the disinfection interface can inject into formaldehyde or hydrogen peroxide (VHP) and other gas disinfection products.

● BIBO itself is equipped with a stainless steel ball valve which makes it easy to inject disinfection products, and make it fully diffuse in the filter surface, disinfect any parts.

● Can test if disinfection product's concentration conforms the requirement of disinfection specification through the inspection sampling mouth on the surface of the filter; examine the effects of disinfection through the sterilization validation of downstream.

### Leakage Testing Device

● HEPA filter has been tested strictly for leakage and filtration efficiency in factory to ensure filter's efficiency to achieve the requirement of customer; (H13 or H14)

● Diameter of aerosol for detection use is 0.3 um, aerosol concentration and size distribution is uniform and stable, can use DEHS, PAO and other substances;

● After the HEPA filter of per level, manual or automatic scanning system is optional, leak detection was carried out on the filter, scanning device test filter efficiency in working status, to test for leakage; According to the GB19489-2008 standard for leakage detection of filter process;

### Fan

● Deploy the fan section according to the requirements of customer, can provide variable frequency motor control, to achieve energy saving purpose;

● German Rosenberg voluteless fan, direct motor drive, avoid the belt dust drive during transmission, reducing bag in bag out own producing dust; with characteristic of high efficiency, low noise, stable performance and easy to clean;

● Fan, Switch brand, made in Shanghai; Past "AMCA" identification and strict dynamic balancing test, maintenance-free ball bearing, high intensity, low noise, stable performance.

### 常用规格 Common Specifications

型号 Model	外形尺寸 Dimension WxHxD (mm)	额定风量 Rated Air Flow (m³/h)	一级过滤器尺寸 First Stage Filter Size WxHxD (mm)	二级过滤器尺寸 Second Stage Filter Size WxHxD (mm)
HBIBO H	1080x772x772(+90)	3400	-	610x610x292/311
HBIBO PH	1380x772x772(+90)	3400	610x610x46	610x610x292/311
HBIBO HH	2160x772x772(+90)	3400	610x610x292/311	610x610x292/311

注：  
1、"+90"为增加90mm的紧固件尺寸  
2、292/311，干式密封过滤器厚度为292mm，液槽密封过滤器厚度为311mm  
3、还需要在更换过滤器方向增加1000mm的更换过滤器空间  
4、通过箱体的并联安装，可获取最大40000CMH；较大并联10个箱体

Remark:  
1) "+90" is fastener size which increased 90mm  
2) 292/311, thickness of dry seal filter is 292mm, flume seal filter is 311mm  
3) Also need to increase 1000 mm space for filter replacement in direction of filter replacement  
4) Through the paralleling of housing, can obtain maximum 40000 CMH; max 10 housing in parallel

### 结构示意图 Structure Drawings

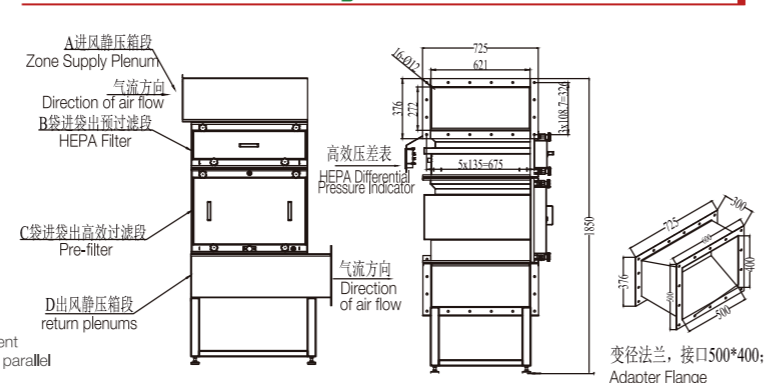

# HWS Hand-washing sink

## HWS 不锈钢洗手池



### 材质说明 Material Instructions

304/316L 不锈钢材质  
拉丝/喷砂，电解抛光处理  
全满焊工艺  
无边缝，易清洁表面及坚固的设计  
水槽数量可选  
挡板可选  
溢水洞可选  
感应式水龙头

采用满焊圆角结构，现场无需额外安装  
易于清洁，满足各类使用场景

304/316L stainless steel material  
Brushed/sandblasted, electrolytic polished finish  
Full full welding process  
No edge seams, easy to clean surface and sturdy design  
Number of sinks optional  
Optional baffle  
Overflow hole optional  
Sensor type faucet  
Full welded rounded corner structure, no additional installation on site  
Easy to clean, meet all kinds of use scenarios



# HWS Hand-washing sink

## HWS 不锈钢洗手池

### 产品介绍 Production Introduction

不锈钢水池用于洁净室、实验室和制造设施中。用304/316L不锈钢，经拉丝/喷砂，电解抛光处理而成。

Stainless steel sinks are used in clean rooms, laboratories and manufacturing facilities. Made of 304/316L stainless steel, brushed/sandblasted and electrolytically polished.

注：1、若遇规格、结构变更，以本公司提供的最新数据为准；有关更新内容请关注本公司网站：[www.hefilter.com](http://www.hefilter.com)

2、本公司接受非表上规格过滤网产品的订货。

Note: 1. In case of specifications or structures changes, HEFIL will provide up-to-date data on website: [www.hefilter.com](http://www.hefilter.com).

2. HEFIL makes various of other models' HRU replaced hepa box which are not listed in above table. Please consult with us if you need.

# PUSH PUSH FILTER PUSH PUSH过滤器



## 材质说明 Material Instructions

介质: 玻璃纤维纸 (防火等级M1/F1)  
 分离剂: 玻璃纤维线  
 密封胶: 聚氯乙烯(PVC防火等级M2)  
 外壳: 穿孔不锈钢X2CrNi 18-09  
 垫片: 双唇, EPT一体成型 (乙烯-丙烯-三聚氰胺)  
 过滤介质: 玻璃纤维纸H14过滤介质  
 Media: Glass fiber paper (fire classification M1/F1)  
 Separators: Glass fiber thread  
 Sealant: Polyvinyl chloride (PVC fire classification M2)  
 Casing: Perforated stainless steel X2CrNi 18-09  
 Gasket: Double lips, EPT moulded in one piece (Ethylene-Propylene-Terpolymere)  
 Filter media: glass fiber paper H14 filter media



# PUSH PUSH FILTER PUSH PUSH过滤器

## 产品介绍 Production Introduction

PUSH PUSH过滤器应用于隔离器, 保障其安全运行且不含任何金属部件, 因此完全可以焚烧, 易于处理。这一特点与模制件的连续安全边缘相结合, 也意味着产品安全且易于使用。

PUSH PUSH过滤器的集成模制连续密封垫确保每次都能获得完美的空气密封, 并且由于使用现代人体工程学设计使操作简单, 即使在使用很厚的隔离手套进行操作时也是如此。

PUSH PUSH filters are applied to isolators to guarantee their safe operation and do not contain any metal parts, so they are completely incinerable and easy to dispose of. This feature, combined with the continuous safety edge of the molded parts, also means that the product is safe and easy to use.

The integrated molded continuous gasket of the PUSH PUSH filter ensures a perfect air seal every time and makes handling easy thanks to the use of modern ergonomics, even when operated with very thick isolation gloves.

## 优势 Advantage

- 效率为H14, 符合EN1822标准
- 渗透率 $\geq 99.995\%$  MPPS/最大局部渗透率 $\leq 10^{-4}$
- 连续使用时最高可达110°C。
- 每个过滤器都要经过EN1822规定的气溶胶单独泄漏测试
- 安装系统使用推拉式系统或其他
- Efficiency of H14, in line with EN1822 standard
- Permeability  $\geq 99.995\%$  MPPS/maximum local permeability  $\leq 10^{-4}$
- Up to 110°C in continuous use.
- Each filter is individually tested for aerosol leakage according to EN1822
- Installation system using push-pull system or other

## 应用 Application

- 用于制药和生物制药行业的粉尘、细菌和气溶胶阻隔。
- Dust, bacterium and aerosol stoppage for Pharmaceutical and Biopharma industries

## 安装示意图 Installation Drawings

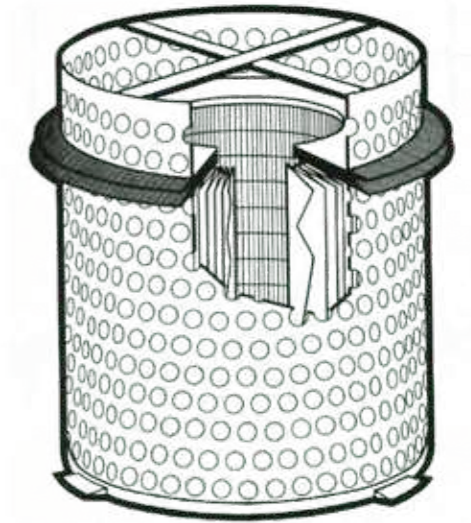

## 常用规格 Common Specifications

型号 Model	额定风量 Rated Air Flow (m³/h)	效率 Efficiency	过滤面积 Filter area (m²)	空气流量 Airflow/ $\Delta p$ m³.h-1/Pa	面板尺寸 Plate Size (mm)
HHD320/10-T	40m³/h	H14	0.7	40/130	154x162

注: 1. 若遇规格、结构变更, 以本公司提供的最新数据为准; 有关更新内容请关注本公司网站: [www.hefil.com](http://www.hefil.com)  
2. 本公司接受非表上规格过滤网产品的订货。

Note: 1. In case of specifications or structures changes, HEFIL will provide up-to-date data on website: [www.hefilter.com](http://www.hefilter.com).

2. HEFIL makes various of other models' HHD gel seal / hepa diffuser which are not listed in above table. Please consult with us if you need.

# HIGH EFFICIENCY TRAPPING BAG

## 高效捕集袋



### 材质说明 Material Instructions

滤袋的形状：圆形袋（圆筒形）  
进出风方式：下进风上出风及上进风下出风和直流式（只限于板状扁袋）  
过滤方式：外滤式及内滤式  
滤料：用纤维、有棉纤维、毛纤维、合成纤维以及玻璃纤维、208或901涤纶绒布

Shape of filter bag: round bag (cylindrical)  
Inlet and outlet air way: down into the wind up into the wind and up into the wind down into the wind and DC type (only limited to plate flat bag)  
Filtration method: external and internal filtration  
Filter media: with fiber, cotton fiber, wool fiber, synthetic fiber and glass fiber, 208 or 901 polyester wheel flannel

# HIGH EFFICIENCY TRAPPING BAG

## 高效捕集袋

### 产品介绍 Production Introduction

捕集袋是一种干式滤尘装置。它适用于捕集细小、干燥、非纤维性粉尘。滤袋采用纺织的滤布或非纺织的毡制成，利用纤维织物的过滤作用对含尘气体进行过滤，当含尘气体进入袋式除尘器后，颗粒大、比重大的粉尘，由于重力的作用沉降下来，落入灰斗，含有较细小粉尘的气体在通过滤料时，粉尘被阻留，使气体得到净化。

The dust collection bag is a dry dust filtering device. It is suitable for capturing fine, dry, non-fibrous dust. The filter bag is made of textile filter cloth or non-woven felt, using the filtering effect of fiber fabric to filter the dust-containing gas. When the dust-containing gas enters the bag filter, the dust with large particles and large specific gravity settles down and falls into the dust hopper due to the effect of gravity, and the gas containing finer dust is retained when passing through the filter media, so that the gas is purified.

### 优势 Advantage

- ◆ 设计过滤精度为0.9-5微米（平均值）
- ◆ 捕集更轻松，适用于固气分离过滤使用，不会因在过滤过程中而漏料
- ◆ 过滤速度更快，减少因物料颗粒堵塞对机器造成的压力
- ◆ 不掉纤维，滤料表面采用镜面技术处理使其光滑平整，具有免清洗功能
- ◆ 较高的防静电技术标准，确保生产无危险
- ◆ 具有较高耐磨性能，捕集袋采用加固抗磨损技术使其经久耐用
- ◆ 使用后无需清洗，因滤料表面采用抗洁露技术处理，物料与滤料表面可自动分离，不粘料
- ◆ 耐温度较高，适合于-20°C--150°C正常使用
- ◆ 耐PH值性能良好，适用于酸性、碱性物料过滤

### 应用 Application

- ◆ 捕集袋应用于：沸腾床干燥机，WBF多功能制粒包衣机，FL系列制粒干燥机，GFG系列流化床干燥机，CGC系列离心造粒包衣机，E系列挤出机，S系列滚圆机，一步制粒机，湿法制粒机，干法制粒机等设备。
- ◆ The catch bag is applied to: boiling bed dryer, WBF multi-functional granulation coating machine, FL series granulation dryer, GFG series fluidized bed dryer, CGC series centrifugal granulation coating machine, E series extruder, S series rounding machine, one-step granulator, wet granulator, dry granulator and other equipment.

- ◆ Design filtration precision is 0.9-5 microns (average value)
- ◆ Easier trapping, suitable for solid-gas separation and filtration, no material leakage in the process of filtration
- ◆ Faster filtration speed, reduce the pressure on the machine caused by material particle blockage
- ◆ No fiber loss, the surface of the filter material is treated with mirror technology to make it smooth and flat, with no cleaning function
- ◆ High anti-static technology standard to ensure the production without danger
- ◆ High wear resistance, the bag is reinforced with anti-abrasion technology to make it durable
- ◆ No need to clean after use, because the surface of the filter material is treated with anti-jelly technology, the material can be separated from the surface of the filter material automatically, without sticking to the material
- ◆ High temperature resistance, suitable for normal use from -20°C to 150°C
- ◆ Good PH resistance, suitable for acidic and alkaline material filtration

# AIR SHOWER HAS 风淋室



## 材质说明 Material Instructions

箱体材质: 箱体外壁采用1.2mm冷轧钢板静电喷涂处理, 表面喷粉, 哑光白色, 内胆双侧采用不锈钢制作, 不锈钢单开门, 配德国欧宝闭门器, 底板铺不锈钢板  
 风机: 专用离心风机, 风机电源为380V/50Hz  
 过滤系统: 采用板式初效过滤器、无隔板高效过滤器, 组合效率可达99.99%@0.3 μ m  
 照明: LED节能小圆灯

Casing material: Outer wall is cold-rolled steel plate with matte white; the internal wall is made of stainless steel sheet; the floor is laid with stainless steel plate; the entrance and exit are equipped with stainless steel single door separately. The whole cabinet is equipped with OPEL door closer which is imported from Germany.  
 The fan: Specified centrifugal fan; power: 380V/50HZ.  
 Filtration system: Mini-pleat HEPA filter work together with primary efficiency panel filter, overall efficiency reaches 99.99%@0.3 μ m.  
 Lighting: Small round LED energy saving lamp.

# AIR SHOWER HAS 风淋室

## 产品介绍 Production Introduction

采用全电脑语音控制, 电子互锁(打开一边门时, 另一边门不打开), 欧姆龙红外线感应器自动吹淋, LED时间计数器控制吹淋时间, 风淋时间0~99s可调。风淋时双门锁闭, 不锈钢喷嘴, 出风口的风速≥25m/s

Control system: Adopt full-computer voice control system. The doors work under electronic interlock (if one doors is open, the other one will be locked). Air blowing works automatically with OMRON Infrared Sensor. The blowing time is controlled by LED time counter, adjustable from 0s to 99s. Blowing way: Both doors are closed when blows; stainless steel nozzles; air outlet velocity ≥ 25m/s.

## 优势 Advantage

- ◆ 箱体材质为优质冷轧钢板静电喷涂处理; 不锈钢底板
- ◆ 大风量双速高压风机, 具有体积小、风量大、高压、低噪音等特点
- ◆ 优质板式初效过滤器、无隔板高效过滤器组合
- ◆ 不锈钢喷嘴, 出风口的风速≥25m/s
- ◆ 欧姆龙红外线感应器
- ◆ 不锈钢单开门, 德国欧宝闭门器
- ◆ 程控系统, 进口电器元件, 感应自动吹淋, LED显示吹淋时间(0~99s可调)
- ◆ Outer casing is made of high-quality cold-rolled steel plate treated by electrostatic spray, floor plate is made of stainless steel sheet.
- ◆ Use double-speed air fans of high pressure and airflow, with features of small size, large air volume, high pressure, low noise etc.
- ◆ Consists of high-quality primary filter and mini-pleat HEPA panel filter...
- ◆ Stainless steel nozzles, air outlet velocity ≥ 25m/s.
- ◆ Omron infrared sensors.
- ◆ Single swinging door made of stainless steel, equipped with OPEL door closer.
- ◆ Programmable logic control system; Imported electrical components; Automatic blowing through sensing; Blowing time (0~99s adjustable) displayed via LED.

## 应用 Application

- ◆ HAS系列风淋室是洁净厂房和装配式洁净小室的配套设备。用于吹除进入净化厂房的人员和携带物品表面附着的尘埃, 同时风淋室也起到气闸的作用, 防止未经净化的空气进入洁净区域。是进行人身净化和防止室外空气污染洁净区的有效设备。
- ◆ Air shower series is applied to clean workshop and serve as corollary equipment for small fabricated clean rooms. It is used to blow off the surface dust of staff and carried things entering the clean room. At the same time, air shower also plays the role of air brake to prevent access of unclean air to clean area. It is effective equipment for personal purification and preventing outdoors air from polluting indoors.

## 结构示意图 Structure Drawings

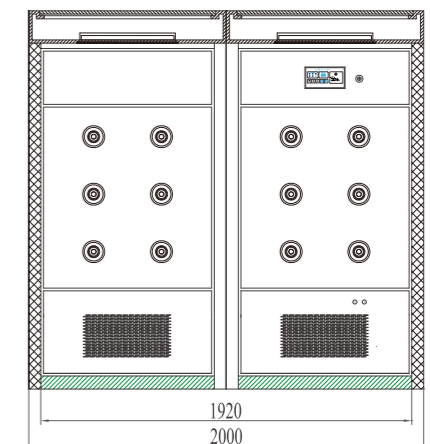
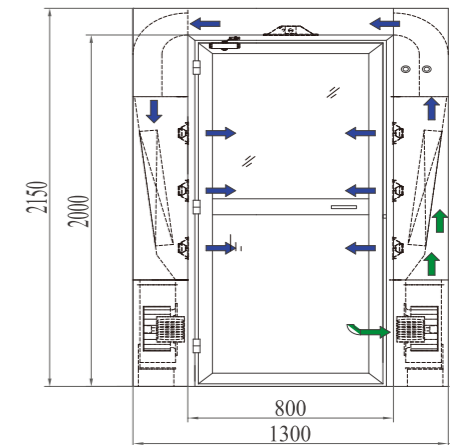

## 常用规格 Common Specifications

型号 Model	形式 Type	过滤效率 HEPA Efficiency	吹淋时间 Shower Time	喷嘴出口风速 Exiting Velocity	喷嘴口径与数量 Nozzle Diameter, Qty	电源 Power Supply	功耗 Power Consumption (W)	外形尺寸 External Dimensions (W×D×H) (mm)	风淋区尺寸 Shower Area (W1×D1×H1) (mm)	重量 Weight (kg)	高效过滤器规格 HEPA Specification
HAS-1A	单人/双侧吹风 1-man/2-side blowing	≥99.99% @0.5μm	0~99s (可调 Adjustable)	≥25m/s	Φ38mm, 16pcs	AC, 3Φ-380/50Hz	≤800	1300×1000×2150	800×920×2000	~400	610×610×70 (mm) 2pcs
HAS-1B	单人/单侧吹风 1-man/1-side blowing				≤400		1100×900×2150	800×820×2000	~350	610×610×70 (mm) 1pcs	
HAS-2A	双人/双侧吹风 2-man/2-side blowing				≤1600		1300×2000×2150	800×1920×2000	~700	610×610×70 (mm) 4pcs	
HAS-2B	双人/单侧吹风 2-man/1-side blowing				≤800		1100×1800×2150	800×1720×2000	~600	610×610×70 (mm) 2pcs	

注: 1、若遇规格、结构变更, 以本公司提供的最新数据为准; 有关更新内容请关注本公司网站: www.hefil.com

2、本公司接受非表上规格过滤网产品的订货。

Note: 1. In case of specifications or structures changes, HEFIL will provide up-to-date data on website: www.hefilter.com.

2. HEFIL makes various of other models' HRU replaced hepa box which are not listed in above table. Please consult with us if you need.

# CLEAN BOOTH HBO 洁净工作棚

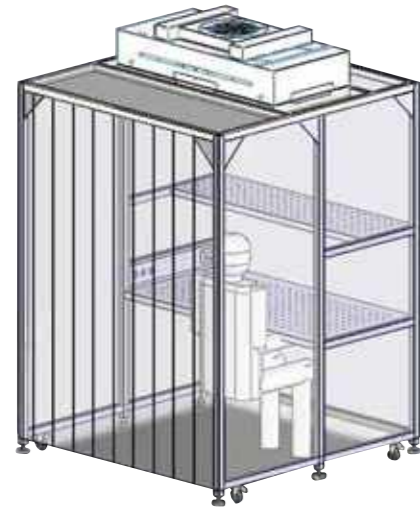

## 材质说明 Material Instructions

框架: 50×50工业铝材(不锈钢方通、喷塑钢方通)  
防静电垂帘: 四周围用防静电垂帘(或钢化玻璃);  
洁净室顶盖板采用标准轧钢板静电喷塑内部采用净化室专用净化灯  
风机滤网机组FFU: 采用离心风机

Frame: 50×50 industrial aluminum (stainless steel square pipe, spraying plastic steel square pipe)  
Anti-static curtain: There is anti-static curtain all around (or tempered glass). The cover of clean booth is made of standard rolled steel plate static electricity spraying. It uses the professional clean luminaries in the interior, non-dust.  
Fan filter unit FFU: Uses centrifugal fan with follow features

# CLEAN BOOTH HBO 洁净工作棚

## 产品介绍 Production Introduction

洁净工作棚是一种可提供局部高洁净环境的空气净化设备。主要由箱体、风机、初效空气过滤器、灯具等组成, 外壳喷塑。该产品既可悬挂, 又可地面支撑, 结构紧凑, 使用方便。可以单个使用, 也可多个连接组成带状洁净区域。

Clean booth is a kind of air purification equipment that can provide local high clean environment. It is mainly composed of box, fan, primary air filter and lamps, etc. The shell is sprayed with plastic. The product can be both suspended and ground supported, with compact structure and easy to use. It can be used as a single unit, and can also be connected to form a strip clean area.

## 优势 Advantage

- ◆ 模块化、组装式设计, 安装方便, 提高洁净等级容易, 扩展性强, 且重复利用价值高, 适用于提高局部洁净区域的洁净度
- ◆ 可安装万向轮, 移动比较方便的简易净化装置
- ◆ 相对无尘操作台, 内部有效使用空间大; 相对传统无尘室成本造价低、施工快、且对楼层高度要求低
- ◆ 可单独使用, 也可组合使用
- ◆ Modularity, compositional design, convenient installation, easy to improve the cleanliness, strong expandability and recyclable, it is applied to improve the cleanliness of clean zone.
- ◆ Can be installed the omni-directional wheel, moving flexible, it is a simple purifying instrument.
- ◆ Interior used space is larger than the non-dust working platform; less expensive, fast construction, loose requirement of floor compared with the traditional non-dust room.
- ◆ It can be used single, also can be used with the other equipment.

## 应用 Application

- ◆ 特别适用于车间内局部净化级别要求高的区域, 如流水线作业区域、高精度产品组装区。
- ◆ Especially suitable for the high cleanliness requirements of the workshop zone, e.g. assembly line work zone, high precision products assembling zone.

## 结构示意图 Structure Drawings

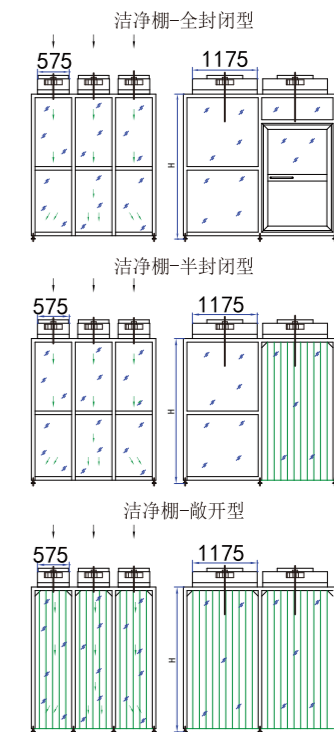

## 常用规格 Common Specifications

面积 Area (m <sup>2</sup> )	10	20	30	40	50	60	70	80	90	100	200	300	400	500	1000	2000	3000	4000	
洁净等级 FS209E	用 量 Quantity (pcs)																		
Class100	12	24	36	48	60	72	84	96	108	120	240	360	480	600	1200	2400	3600	4800	
Class1000	4	8	12	16	20	24	28	32	36	40	80	120	160	200	400	800	1200	1600	
Class10000	2	4	6	8	10	12	14	16	18	20	40	60	80	100	200	400	600	800	

1. 百级洁净度: 满布 FFU;  
2. 千级洁净等级换算公式:  $\frac{X \text{立方米} \times (60-100) / \text{h}}{\text{FFU风量}}$   
3. 万级洁净等级换算公式:  $\frac{X \text{立方米} \times (30-60) / \text{h}}{\text{FFU风量}}$   
本数据未大约用量仅供参考, 具体按现场实际情况来定

注: 1. 若遇规格、结构变更, 以本公司提供的最新数据为准; 有关更新内容请关注本公司网站: www.hefil.com  
2. 本公司接受非表上规格过滤网产品的订货。  
Note: 1. In case of specifications or structures changes, HEFIL will provide up-to-date data on website: www.hefilter.com.  
2. HEFIL makes various of other models' HRU replaced hepa box which are not listed in above table. Please consult with us if you need.



# CLEAN BENCH HCB 洁净工作台



## 材质说明 Material Instructions

工作台材质: 整体材质为优质冷轧钢板静电喷塑处理, 工作台面为不锈钢材质, 两侧装有透明钢化玻璃  
 控制系统: 采用触摸式电子控制面板  
 气流方式: 水平层流型或垂直层流型  
 风机: 专用离心风机  
 过滤系统: 超薄型无隔板高效过滤器, 过滤效率可达 99.99% @ 0.3 μm

Casing material: High-quality cold-rolled steel plate treated by electrostatic spray; Working table surface is of stainless steel; Both sides of the bench are equipped with transparent toughened glass.  
 Control system: Electronic touch-control panel.  
 Two types of device: Horizontal laminar flow & vertical laminar flow.  
 Fan: Special centrifugal fan.  
 Filtration system: Mini-pleat HEPA filter, filter efficiency reach 99.99% @ 0.3 μm.

# CLEAN BENCH HCB 洁净工作台

## 产品介绍 Production Introduction

洁净工作台是一种通用性较强的局部净化设备, 按气流流行分为垂直单向流和水平单向流两大形式。净化工作台广泛应用于医药、食品、科研、电子、国防、精密仪器仪表等行业。

Clean bench is a kind of general-purpose local purification equipment, which is divided into two major forms of vertical unidirectional flow and horizontal unidirectional flow according to the popularity of airflow. Clean bench is widely used in medicine, food, scientific research, electronics, national defense, precision instrumentation and other industries.

## 优势 Advantage

- 工作台整体材质为优质冷轧钢板静电喷塑处理
- 大风量高效离心风机, 具有体积小、风量大、高压、低噪音等特点
- 采用超薄型无隔板高效空气过滤器, 占用空间小
- 工作台面为不锈钢材质, 耐磨易清洁
- 两侧装有透明钢化玻璃, 增加采光度
- 底部装有水平调整脚及万向轮, 定位移动方便
- 采用触摸式电子控制面板, 风机风量可无级调节, 保证工作区的风速始终处于理想状态
- 可配备紫外灯远程控制电气接口
- 水平层流型或垂直层流型
- 洁净度: ISO Class 5 / FS209E 100级 ( $\geq 0.5\mu\text{m}$  尘埃数  $\leq 3.5$  颗/升)
- 平均风速 0.35~0.55m/s
- 噪声  $\leq 64\text{dB(A)}$
- Outer casing is made of high-quality cold-rolled steel plate treated by electrostatic spray.
- Use high capacity and high efficiency centrifugal fan, which is with the feature of small size, large air flow, high pressure and low noise etc.
- Adopt ultra-thin mini pleat filter and occupies small space.
- Working table surface is made of stainless steel, which is durable and easy to clean.
- Both sides of the bench are equipped with transparent toughened glass, effectively increase day lighting.
- Bottom of the table is equipped with leveling feet and omni-directional wheels, easy to move and position.
- To ensure the ideal state of air velocity in working area, the fan flow can be regulated steplessly by electronic touch-control panel.
- The electric remote control interface can be equipped with ultraviolet light.
- Two types of device: Horizontal laminar flow & vertical laminar flow.
- Cleanliness: ISO Class 5 / FS209E Class 100 ( $\geq 0.5\mu\text{m}$  dust particles  $\leq 3.5$  A/l).
- Air Velocity: 0.35~0.55m/s.
- Noise:  $\leq 64\text{dB(A)}$ .

## 应用 Application

- ◆ 主要用于电子、生物、医药、精密仪器等行业的高洁净度的操作环境, 是一种通用性较强的局部空气净化设备。
- ◆ Clean bench is used to electronics, biology, medicine, precision instruments and other industries require high level cleanliness. It is very universal air purification equipment aiming at partial filtration.

## 结构示意图 Structure Drawings

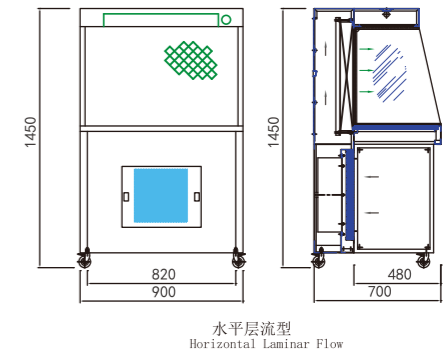
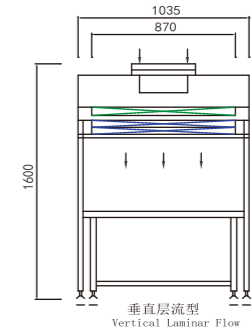

## 常用规格 Common Specifications

型号 Model	形式 Type	气流方式 Air Stream Direction	平均风速 Power Supply	噪声 Noise	电源 Power Supply	功耗 Power Consumption (kW)	重量 Weight (kg)	外形尺寸 External Dimensions (W×D×H) (mm)	工作区尺寸 Working Area (W×D×H) (mm)	HEPA 过滤器 HEPA Outfit	荧光灯 /紫外灭菌灯 Fluorescent /Ultraviolet	照度 Luminosity	可操作人数 Seating Capacity
标准型Normal HCB-1H		水平层流型 Cross Flow Laminar	0.3~0.5m/s (可调Adjustable)	$\leq 62$	AC, 1Φ- 220V/50Hz	0.4	160	900×700×1450	820×480×600	820×600×50, 1pcs	20W/20W	$\geq 300\text{Lx}$	单人单面 1-man, 1-side
标准型Normal HCB-2H						0.8	260	1760×700×1450	1680×480×600	820×600×50, 2pcs	40W/30W	$\geq 300\text{Lx}$	双人单面 2-man, 1-side
医用型Medical HCB-1V		垂直层流型 Down Flow Laminar	0.3~0.5m/s (可调Adjustable)	$\leq 62$	AC, 1Φ- 220V/50Hz	0.4	150	1035×700×1600	870×680×525	820×600×50, 1pcs	20W/20W	$\geq 300\text{Lx}$	单人双面 1-man, 2-side
医用型Medical HCB-2V						0.8	350	1665×700×1600	1510×680×525	820×600×50, 1pcs 600×600×50, 1pcs	30W×2/30W×2	$\geq 300\text{Lx}$	双人双面 2-man, 2-side

注: 1、若遇规格、结构变更, 以本公司提供的最新数据为准; 有关更新内容请关注本公司网站: www.hefil.com

2、本公司接受非表上规格过滤网产品的订货。

Note: 1. In case of specifications or structures changes, HEFIL will provide up-to-date data on website: www.hefiller.com.

2. HEFIL makes various of other models' HRU replaced hepa box which are not listed in above table. Please consult with us if you need.

# HBX LAMINAR PASS BOX

## HBX 自净传递窗



### 材质说明 Material Instructions

箱体材质: 外箱体表面采用优质冷轧薄钢板或全不锈钢板, 内箱体表面采用不锈钢板  
 联锁方式: 机械联锁或电子联锁  
 对讲系统: 响铃式, 内外人员通话  
 玻璃视窗: 黄光贴膜, 防紫外线、防静电  
 杀菌灯: 紫外线杀菌灯

Casing material: Outer casing is made of high-quality cold-rolled steel sheet or stainless steel plate; Inner casing is made of stainless steel plate.  
 Interlocking way: Mechanical interlocking or electronic interlocking.  
 Intercom system: Bell type; Between the door sides person communicate by phone.  
 Glass sash: Yellow sticker, anti-UV and anti-static  
 Sterilizer light: UV sterilizer.

# HBX LAMINAR PASS BOX

## HBX 自净传递窗

### 产品介绍 Production Introduction

自净传递窗可以在A级环境保护下传递物料、器具等。物品在窗内自净后进入更高洁净度区域。自净传递窗内配有紫外线杀菌灯, 也可根据用户需求配置臭氧灭菌系统。

Self-cleaning transfer windows can transfer materials, appliances, etc. under Class A environmental protection. The items are self-cleaned in the window and then enter the higher cleanliness area. Self-cleaning transfer window is equipped with ultraviolet sterilization lamp, also can be configured according to user needs ozone sterilization system.

### 优势 Advantage

- 传递窗的内箱体表面采用不锈钢工作台面, 平整光洁
- 箱体采用优质冷轧薄钢板或全不锈钢板制成
- 采用机械联锁或电子联锁, 可防止两侧门同时被打开
- The work surface of internal cabinet is made of stainless steel, flat and smooth.
- Outer casing is made of high-quality cold-rolled steel or stainless steel sheet.
- Apply mechanical or electronic interlocking, effectively prevent both sides of the door opening at the same time.

### 应用 Application

- 主要用于洁净区与洁净区之间、洁净区与非洁净区之间物品的传递, 把对洁净室的污染降到最低程度。
- Mainly used in situation when goods should be delivered between clean areas or delivered from clean area to non-clean area, it is to minimize the contamination of clean room.

### 结构示意图 Structure Drawings

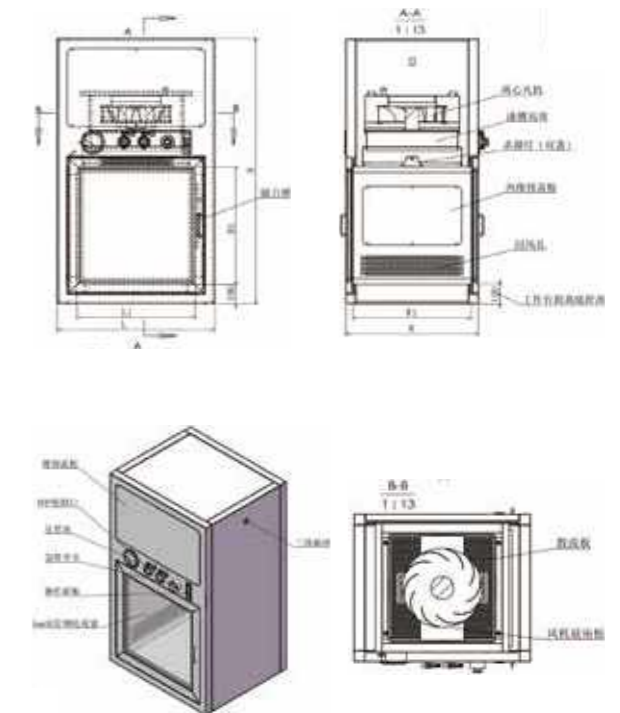

### 常用规格 Common Specifications

型号 Model	外形尺寸 Dimensions WxHxD (mm)	工作区尺寸 Working Area WxHxD (mm)
HBX-555	690×590×500	500×500×500
HBX-556	690×590×600	500×500×600
HBX-666	790×690×600	600×600×600
HBX-667	790×690×700	600×600×700
HBX-777	890×790×700	700×700×700

注: 1. 若遇规格、结构变更, 以本公司提供的最新数据为准; 有关更新内容请关注本公司网站: www.hefil.com  
 2. 本公司接受非表上规格过滤网产品的订货。

Note: 1. In case of specifications or structures changes, HEFIL will provide up-to-date data on website: www.hefilter.com.  
 2. HEFIL makes various of other models' HRU replaced hepa box which are not listed in above table. Please consult with us if you need.

# Explosion-proof laminar flow transfer window

## HRPB 防爆层流传递窗



### 材质说明 Material Instructions

箱体材质: 采用不锈钢板, 表面进行抛光处理  
 控制系统: 采用电子连锁装置两门互锁  
 内壁设计: 内壁采用圆弧结构, 无死角  
 玻璃视窗: 双层玻璃, 表面平整, 不易积尘, 易清洁  
 密闭方式: 点胶发泡一体成型密封条, 有效提升密闭效果  
 维护方式: 过滤器可单独从箱体进行拆卸和安装, 便于维护和更换

Box material: stainless steel plate, surface polishing treatment  
 Control system: electronic interlocking device is used to interlock the two doors  
 Inner wall design: the inner wall adopts rounded structure, no dead angle  
 Glass window: double glass, smooth surface, not easy to accumulate dust, easy to clean  
 Sealing method: the sealing strip is made of foam, which can effectively improve the sealing effect  
 Maintenance method: the filter can be disassembled and installed from the box alone, easy to maintain and replace

# Explosion-proof laminar flow transfer window

## HRPB 防爆层流传递窗

### 产品介绍 Production Introduction

防爆层流传递窗是具有防爆性质的新型洁净传递窗。空气经粗效过滤后, 由低噪音离心风机压入静压箱, 再经高效过滤器, 均压以后以均匀的风速通过工作区, 形成洁净的工作环境。出风面也可以改用喷嘴来提高风速, 以满足吹落物体表面尘埃的要求。

Explosion-proof laminar flow transfer window is a new type of clean transfer window with the nature of explosion-proof. After coarse filtration, the air is pressed into the static pressure box by a low-noise centrifugal fan, and then through the high-efficiency filter, the uniform pressure is passed through the working area with uniform air speed to form a clean working environment. The air outlet surface can also be changed to use nozzles to increase the wind speed to meet the requirements of blowing down the dust on the surface of objects.

### 优势 Advantage

- 具有防爆特性, 可适用于多种场景
- 双门采用电子连锁装置, 两门不可同时打开
- 双门采用内嵌式, 内嵌于箱体, 外表面平整
- 配备压差表, 实时监测寿命
- 腔体内四角圆弧设计, 清洁无死角
- Explosion-proof characteristics, can be applied to a variety of scenes
- Double doors adopt electronic chain device, two doors cannot be opened at the same time
- The double doors are embedded, embedded in the box, and the outer surface is flat
- Equipped with differential pressure gauge, real-time monitoring of life
- The four corners of the chamber are designed with rounded corners, no dead angle for cleaning

### 应用 Application

- 主要用于生物洁净区作为物品的传递, 主要应用场所: 生物制药、科研单位, 疾控中心, 大型医院, 大学科研, 生物洁净及各种洁净区。
- 可于石油、化工、燃气、冶金、纺织、采矿、制药、食品、粮油加工等含尘气体度较高或具有易燃易爆介质隐患的行业。
- Mainly used in biological clean area as the transfer of goods, the main application places: biopharmaceuticals, scientific Research units, CDC, large hospitals, university research, biological cleanliness and various clean areas.
- It can be used in petroleum, chemical industry, gas, metallurgy, textile, mining, pharmaceutical, food, grain and oil processing, etc. It can be used in petroleum, chemical, gas, metallurgy, textile, mining, pharmaceutical, food, grain and oil processing and other industries with high degree of dusty gas or hidden danger of flammable and explosive media.

### 结构示意图 Structure Drawings

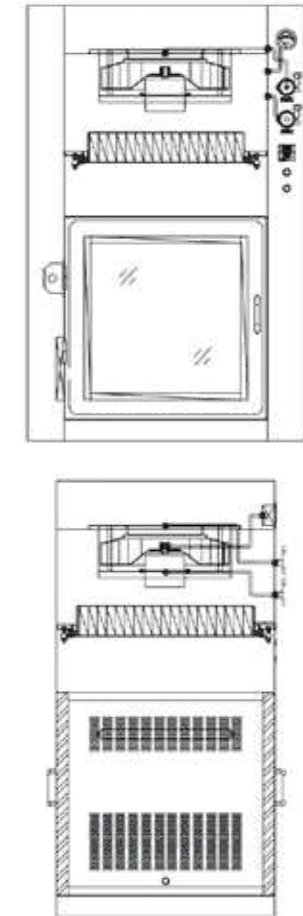

### 常用规格 Common Specifications

型号 Model	外形尺寸 Dimensions WxHxD (mm)	内腔尺寸 Inner cavity WxHxD (mm)
HRPB-500	680×500×590	500×500×500
HRPB-600	780×600×690	600×600×600
HRPB-750	880×700×790	700×700×700

注: 1、若遇规格、结构变更, 以本公司提供的最新数据为准; 有关更新内容请关注本公司网站: www.hefil.com  
 2、本公司接受非表上规格过滤网产品的订货。  
 Note: 1. In case of specifications or structures changes, HEFIL will provide up-to-date data on website: www.hefilter.com.  
 2. HEFIL makes various of other models' HRU replaced hepa box which are not listed in above table. Please consult with us if you need.

# HYDROGEN PEROXIDE TRANSFER WINDOW

## HVHP 过氧化氢传递窗



### 材质说明 Material Instructions

箱体材质: 舱体外壳和框架采用304不锈钢, 内腔及工作台面等采用316L不锈钢, 透明操作面板采用钢化玻璃  
 控制系统: PLC可编程控制系统  
 杀菌方式: 汽化过氧化氢灭菌系统  
 玻璃视窗: 黄光贴膜, 防紫外线、防静电

Cabinet material: cabin shell and frame using 304 stainless steel, inner cavity and work surface, etc. using 316L stainless steel, transparent operating panel using tempered glass  
 Control system: PLC programmable control system  
 Sterilization method: vaporized hydrogen peroxide sterilization system  
 Glass window: yellow light film, anti-UV, anti-static

# HYDROGEN PEROXIDE TRANSFER WINDOW

## HVHP 过氧化氢传递窗

### 产品介绍 Production Introduction

过氧化氢传递窗通过集成的汽化过氧化氢灭菌对传递窗内的所有暴露表面进行灭菌, 包括脂类、蛋白质和DNA组织, 取代传统紫外消毒的方法, 达到完全灭菌的要求; 汽化过氧化氢具有良好的物料兼容性, 最终分解为水和氧气, 无有害残留。主要应用于制药行业无菌洁净室与洁净室之间的物料传递。

The hydrogen peroxide transfer window sterilizes all exposed surfaces inside the transfer window, including lipids, proteins and DNA tissues, through integrated vaporized hydrogen peroxide sterilization, replacing the traditional UV disinfection method to achieve complete sterilization; vaporized hydrogen peroxide has good material compatibility and eventually decomposes into water and oxygen with no harmful residues. It is mainly used for material transfer between sterile clean room and clean room in pharmaceutical industry.

### 优势 Advantage

- ◆ 采用进口充气式高密度密封条, 有较强密封性能
- ◆ 门框门页连接气管内置, 减少清洁难度
- ◆ 灭菌过程中不升温, 与初始温度一致, 适合生物制品
- ◆ 灭菌快, 小舱体灭菌周期30分钟, 大舱体灭菌周期只有50分钟
- ◆ 不属于危险化学品, 运输、储存、使用都无需备案
- ◆ Imported inflatable high-density seal, with strong sealing performance
- ◆ The door frame and door page are connected with built-in air tube, which reduces the difficulty of cleaning
- ◆ No temperature rise during sterilization, consistent with the initial temperature, suitable for biological products
- ◆ Fast sterilization, 30 minutes sterilization cycle for small compartments and 50 minutes sterilization cycle for large compartments
- ◆ Not a dangerous chemical, no need to record for transportation, storage

### 应用 Application

- ◆ 用于无菌原料药的传递
- ◆ 用于无菌检查实验室、微生物检查实验室、取样间、物料传递间、重症监护病房 (ICU)、负压隔离病房、传染病房等
- ◆ 实验室 (病毒、细菌)、手术室发热门诊、病理科和检验科、药物配置室/静脉药物配置中心 (PIVAS)、供应室、急救车等区域的物料传递
- ◆ 用于不能高温灭菌的物料不同级别的传递
- ◆ For the transmission of sterile raw materials
- ◆ Used in sterile examination laboratory, microbiological examination laboratory, sampling room, material delivery room, ICU, negative pressure isolation ward, infectious disease room, etc.
- ◆ Laboratory (virus, bacteria), operating room fever clinic, pathology and laboratory, drug allocation Room / PIVAS, supply room, emergency vehicles and other areas of material transfer
- ◆ For the transfer of materials at different levels that can't be autoclaved

### 结构示意图 Structure Drawings

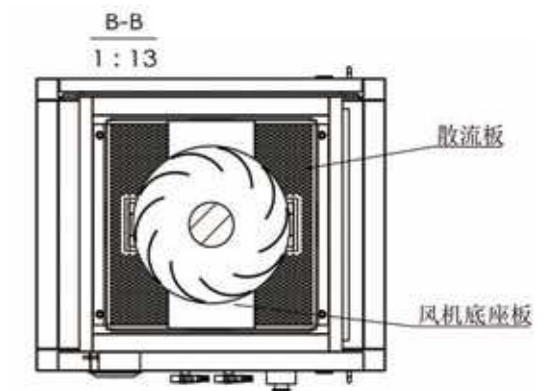
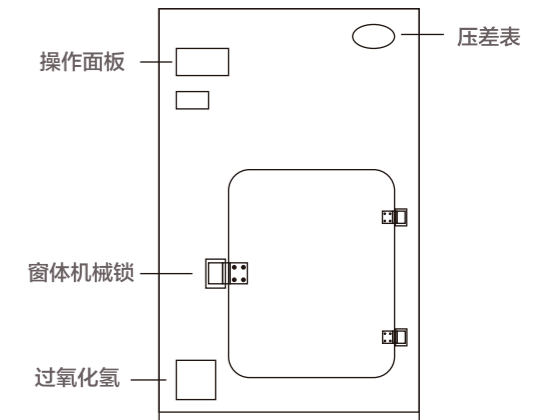

### 常用规格 Common Specifications

型号 Model	外形尺寸 Dimensions WxHxD (mm)	内腔尺寸 Inner cavity WxHxD (mm)
HVHP-1500	1795×1200×1800	1100×1100×1200
HVHP-600	1495×900×1600	800×800×1000
HVHP-125	1000×880×1790	500×700×500

注: 1、若遇规格、结构变更, 以本公司提供的最新数据为准; 有关更新内容请关注本公司网站: www.hefil.com  
 2、本公司接受非表上规格过滤网产品的订货。  
 Note: 1. In case of specifications or structures changes, HEFIL will provide up-to-date data on website: www.hefilter.com.  
 2. HEFIL makes various of other models' HRU replaced hepa box which are not listed in above table. Please consult with us if you need.

# HYDROGEN PEROXIDE STERILE ISOLATORS

## HBX 过氧化氢无菌隔离器



### 材质说明 Material Instructions

箱体材质: 舱体外壳和框架采用304不锈钢, 内腔及工作台面等采用316L不锈钢, 透明操作面板采用钢化玻璃  
 控制系统: 工业平板电脑+PLC控制系统  
 手套/袖套: PVC等软性材料  
 杀菌方式: 汽化过氧化氢灭菌系统  
 玻璃视窗: 黄光贴膜, 防紫外线、防静电  
 Cabinet material: cabin shell and frame using 304 stainless steel, inner cavity and work surface, etc. using 316L stainless steel, transparent operating panel using tempered glass  
 Control system: industrial tablet PC + PLC control system  
 Glove / sleeve: PVC and other soft materials  
 Sterilization method: vaporized hydrogen peroxide sterilization system  
 Glass window: yellow light film, anti-UV, anti-static

# HYDROGEN PEROXIDE STERILE ISOLATORS

## HBX 过氧化氢无菌隔离器

### 产品介绍 Production Introduction

过氧化氢无菌隔离器为产品、人员和环境提供高等级防护, 使人员和环境免于暴露在有传染可能的气溶胶中, 同时保护产品不受外部环境污染。隔离器可集成核酸提取仪、PCR扩增仪、离心机等多种设备, 用于涉及重组DNA分子、含重组DNA分子的有机体、危险病原体或其他未知病原体等传染性材料的工作, 如病毒培养、病毒核酸提取、高致病性病原微生物检验等操作, 为上述操作提供一个无菌、安全的环境。

Hydrogen peroxide sterile isolators provide a high level of protection for products, people and the environment from exposure to potentially infectious aerosols, while protecting products from external environmental contamination. The isolator can be integrated with a variety of equipment such as nucleic acid extractors, PCR amplifiers, and centrifuges for work involving infectious materials such as recombinant DNA molecules, organisms containing recombinant DNA molecules, dangerous pathogens or other unknown pathogens, such as virus culture, virus nucleic acid extraction, and highly pathogenic microbial testing operations, providing a sterile and safe environment for the above operations.

### 优势 Advantage

- ◆ 自动气体灭菌器灭菌, 省时省力, 气体分布均匀, 效果较好
- ◆ 与外界\*隔离, 仅通过HEPA进行空气交换, 并可恒定隔离舱内的压力以阻绝外界污染
- ◆ 采用双门快速传递系统, 保证了在无菌环境中的传递
- ◆ 能够明显降低操作和维护的成本
- ◆ Automatic gas sterilizer sterilization, save time and effort, uniform gas distribution, better results.
- ◆ Isolation from the outside world\*, air exchange only through HEPA, and constant pressure in the isolation chamber to block outside contamination.
- ◆ Double-door fast delivery system ensures delivery in a sterile environment.
- ◆ Can significantly reduce the cost of operation and maintenance.

### 应用 Application

- ◆ 主要用于洁净区与洁净区之间、洁净区与非洁净区之间物品的传递, 把对洁净室的污染降到最低程度。
- ◆ Mainly used in situation when goods should be delivered between clean areas or delivered from clean area to non-clean area, it is to minimize the contamination of clean room.

### 结构示意图 Structure Drawings

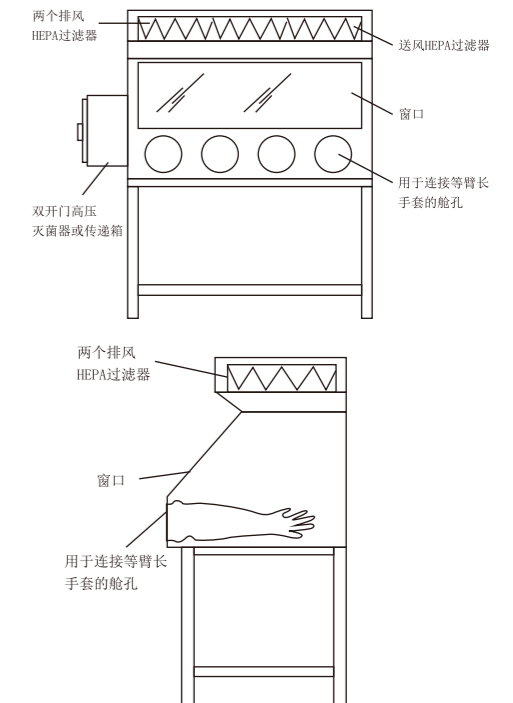

### 常用规格 Common Specifications

型号 Model	外形尺寸 Dimensions WxHxD (mm)	组合方式 Combination method	操作空间 Working Area WxHxD (mm)
HTY-RT1200S	1670x830x1920	单面紊流操作单舱体	1250x750x730
HTY-RT600S	2020x830x1920	单面紊流操作单舱体	1600x750x730
HTY-RT1600D	2020x1213x1920	双面紊流操作单舱体	1600x1200x730
HTY-RT1600S	2653x865x1920	单面紊流操作单舱体+传递舱组合系列	1600x710x730
HTY-RT1600D	2300x865x1920	双面紊流操作单舱体+传递舱组合系列	1590x1200x730
HTY-RT1800S	2220x830x1920	单面紊流操作单舱体	1800x750x730
HTY-RT1800D	2220x1213x1920	双面紊流操作单舱体	1800x1200x730
HTY-RT1800S	2433x865x1920	单面紊流操作单舱体+传递舱组合系列	1800x710x730
HTY-RT1800D	2500x1213x1920	双面紊流操作单舱体+传递舱组合系列	1790x1200x730
HTY-RT2400D	2820x1213x1920	双面紊流操作单舱体	2400x1200x730
HTY-RT2400D	3100x1250x1920	双面紊流操作单舱体+传递舱组合系列	2390x1200x730

注: 1. 若遇规格、结构变更, 以本公司提供的最新数据为准; 有关更新内容请关注本公司网站: www.hefil.com  
 2. 本公司接受非表上规格过滤网产品的订货。

Note: 1. In case of specifications or structures changes, HEFIL will provide up-to-date data on website: www.hefilter.com.  
 2. HEFIL makes various of other models' HRU replaced hepa box which are not listed in above table. Please consult with us if you need.

# HFL LIQUID FILTER

## HFL 不锈钢液体过滤器



### 材质说明 Material Instructions

壳体制造材料: 不锈钢304, 316L  
 滤芯接口型式: 插入式222型, 长度10"、20"、30"  
 过滤精度: 0.1 μm、0.2 μm、0.5 μm、1.0 μm  
 工作压力: 0.3MPa-0.8MPa  
 工作温度: 0-100℃ (或介于各类液体的冰点与沸点之间)

Shell manufacturing material: stainless steel 304, 316L  
 Cartridge interface type: inserted 222 type, length 10", 20", 30"  
 Filtration precision: 0.1 μm, 0.2 μm, 0.5 μm, 1.0 μm  
 Working pressure: 0.3MPa-0.8MPa  
 Working temperature: 0-100°C (or between the freezing point and boiling point of various liquids)

# HFL LIQUID FILTER

## HFL 不锈钢液体过滤器

### 产品介绍 Production Introduction

HFL 不锈钢液体过滤器是一种多功能膜分离技术, 由过滤器壳体和滤芯组成过滤单元, 用304或316L不锈钢制成, 以折叠式膜滤芯为过滤元件, 可滤除液体、气体中0.1um以上的微粒和细菌。

HFL liquid filter is a multi-functional membrane separation technology, consisting of filter housing and cartridge as filtration unit, made of 304 or 316L stainless steel, with folded membrane cartridge as filtration element, which can filter out particles and bacteria above 0.1um in liquid and gas.

### 优势 Advantage

- ◆ 过滤精度高、过滤速率高
- ◆ 壳体耐酸碱腐蚀、操作方便
- ◆ 物料吸附少、无介质脱落、不泄漏
- ◆ 可以组成多级过滤, 达到过滤效果
- ◆ 根据现场工艺要求, 壳体与滤芯采用多种搭配方式
- ◆ High filtration precision and high filtration rate
- ◆ The shell is acid and alkali resistant, easy to operate
- ◆ Less material adsorption, no media shedding, no leakage
- ◆ Multi-stage filtration can be formed to achieve filtration effect
- ◆ According to the site process requirements, the shell and the filter element adopt a variety of matching methods.

### 应用 Application

- ◆ 可以安装各类用于液体过滤的折叠式滤芯, 组成一套完整的液体过滤器。适用于食品、医药、化工、电子、环保等行业的各类液体的净化过滤。
- ◆ can be installed with various types of folded cartridges for liquid filtration. Suitable for food, medicine, chemical, electronic, environmental protection and other It is suitable for the purification and filtration of various liquids in food, pharmaceutical, chemical, electronic, environmental protection and other industries.

### 结构示意图 Structure Drawings

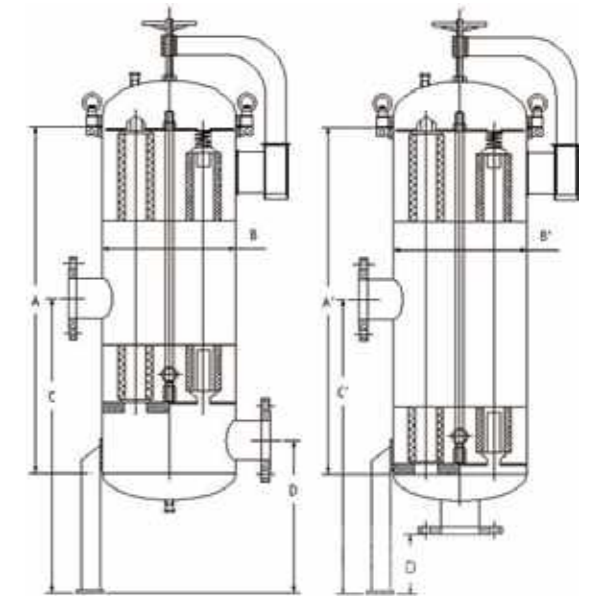

### 常用规格 Common Specifications

额定过滤能力 Design Standards	壳体代号 Shell code	滤芯配置 Cartridge configuration		进出口接管 Import/export receivership		外形尺寸 (mm) Dimension (mm)					参考重量 (kg) Reference weight (kg)
		芯数 Number of cores	长度 Length	d (mm)	连接型式 Connection type	D	W	H	h1	h2	
0.5	HFL-0110	1芯	10"	DN20	卡箍	Φ 102	260	564	120	360	4.5
1	HFL-0120		20"					814		600	5.5
1.5	HFL-0130		30"					1064		840	6.5
3	HFL-0310	3芯	10"	DN25	卡箍	Φ 184	360	632	150	360	10
4.5	HFL-0320		20"					882		600	14
2.5	HFL-0330		30"					1132		840	18
5	HFL-0510	5芯	10"	DN40	或 法兰	Φ 234	380	716	150	410	19
7.5	HFL-0520		20"					966		650	23
8	HFL-0530		30"					1216		890	27
12	HFL-0820	8芯	20"	DN50	法兰	Φ 304	450	966	200	670	35
16	HFL-0830		30"					1236		910	40
16	HFL-0840		40"					1486		1150	45
12	HFL-1220	12芯	20"	DN65	法兰	Φ 354	500	1041	200	685	45
18	HFL-1230		30"					1291		925	50
24	HFL-1240		40"					1541		1165	55
17	HFL-1720	17芯	20"	DN80	法兰	Φ 404	550	1118	200	695	61
25.5	HFL-1730		30"					1368		935	66
34	HFL-1740		40"					1618		1175	74
21	HFL-2120	21芯	20"	DN80	法兰	Φ 454	600	1142	200	710	70
31	HFL-2130		30"					1392		950	76
42	HFL-2140		40"					1642		1190	82
30	HFL-3020	30芯	20"	DN100	法兰	Φ 505	650	1183	200	720	91
45	HFL-3030		30"					1433		960	99
60	HFL-3040		40"					1683		1200	107

注: 1、若遇规格、结构变更, 以本公司提供的最新数据为准, 有关更新内容请关注本公司网站: www.hefil.com  
 2、本公司接受非表上规格过滤网产品的订货。

Note: 1. In case of specifications or structures changes, HEFIL will provide up-to-date data on website: www.hefilter.com.  
 2. HEFIL makes various of other models' HRU replaced hepa box which are not listed in above table. Please consult with us if you need.

# HFG GAS FILTER

## HFG 不锈钢气体过滤器



### 材质说明 Material Instructions

壳体制造材料: 不锈钢304, 316L  
 滤芯接口型式: 卡入式226型, 长度10"、20"  
 过滤精度: 0.1 μm、0.2 μm、0.5 μm、1.0 μm  
 工作压力: 0.3MPa-0.8MPa  
 最高工作温度: 130℃

Shell manufacturing material: stainless steel 304, 316L  
 Cartridge interface type: Snap-in 226 type, length 10", 20"  
 Filtration precision: 0.1 μm, 0.2 μm, 0.5 μm, 1.0 μm  
 Working pressure: 0.3MPa-0.8MPa  
 Maximum working temperature: 130℃

# HFG GAS FILTER

## HFG 不锈钢气体过滤器

### 产品介绍 Production Introduction

HFG不锈钢气体过滤器是一种多功能膜分离技术, 由过滤器壳体和滤芯组成过滤单元, 用304或316L不锈钢制成, 以折叠式膜滤芯为过滤元件, 可滤气体中0.1um以上的微粒和细菌。

HFG Gas filter is a multi-functional membrane separation technology, consisting of filter housing and cartridge as filtration unit, made of 304 or 316L stainless steel, with folded membrane cartridge as filtration element, which can filter bacteria above 0.1um in liquid and gas.

### 优势 Advantage

- ◆ 过滤精度高、过滤速率高
- ◆ 壳体耐酸碱腐蚀、操作方便
- ◆ 物料吸附少、无介质脱落、不泄漏
- ◆ 可以组成多级过滤, 达到过滤效果
- ◆ 根据现场工艺要求, 壳体与滤芯采用多种搭配方式
- ◆ High filtration precision and high filtration rate
- ◆ The shell is acid and alkali resistant, easy to operate
- ◆ Less material adsorption, no media shedding, no leakage
- ◆ Multi-stage filtration can be formed to achieve filtration effect
- ◆ According to the site process requirements, the shell and the filter element adopt a variety of matching methods.

### 应用 Application

- ◆ HFG不锈钢气体过滤器可以安装各类用于气体过滤的折叠式滤芯, 组成一套完整的气体过滤器。设计合理, 结构紧凑, 安装使用和清洗方便, 适用于食品、医药、化工、电子等行业的气体过滤。
- ◆ HFG Gas Filter can be installed with various types of folded cartridges for gas filtration to form a complete set of gas filter. With reasonable design, compact structure, easy to install and use and clean, it is suitable for gas filtration in food, pharmaceutical, chemical, electronic and other industries.

### 结构示意图 Structure Drawings

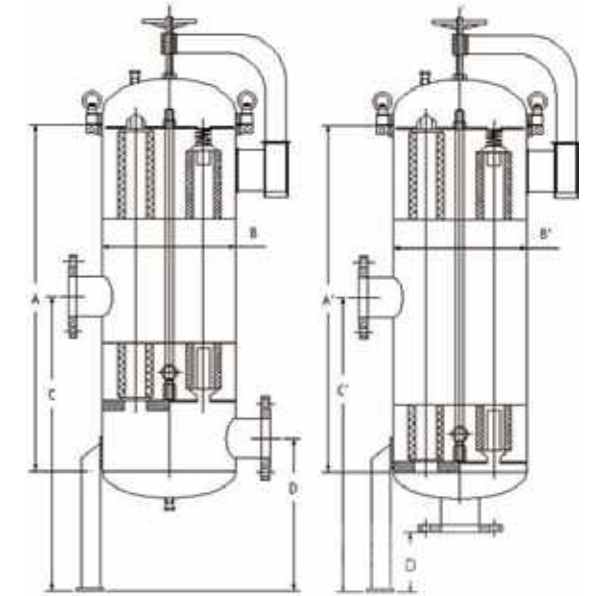

### 常用规格 Common Specifications

额定 过滤能力 (m <sup>3</sup> /min)	壳体代号	滤芯配置		进出口接管		外形尺寸 (mm)					参考 重量(kg)	
		芯数	长度	d (mm)	连接 型式	D	W	H	h1	h2		
0.5	HFG-0105-1"	1芯	5"	DN25 (Φ32x3)	法兰	Φ114	234	434	-	250	5	
2	HFG-0110-1"		10"					549		370		8
4	HFG-0120-1"		20"					800		610		
6	HFG-0310-2"	3芯	10"	DN50 (Φ57x3.5)	法兰	Φ184	324	789	300	400	15	
10	HFG-0320-2.5"		DN65 (Φ76x4)	1046				640		23		
15	HFG-0520-3"	5芯	20"	DN80 (Φ89x4)	法兰	Φ234	414	1178	380		653	32
20	HFG-0520-4"			DN100 (Φ108x4)				1191		385	35	
30	HFG-0720-4"	7芯		DN125 (Φ133x4)				1251	426	663		42
40	HFG-0920-5"			9芯				DN150 (Φ159x4.5)	1303	438	698	
60	HFG-1220-5"	12芯						DN200 (Φ219x6)	1346	450	710	85
80	HFG-1520-6"			15芯				DN250 (Φ273x6)	1375		505	
100	HFG-1920-6"	19芯						DN200 (Φ219x6)	1501	505		735
120	HFG-2520-8"			25芯					DN250 (Φ273x6)		1514	
150	HFG-3020-8"	30芯						DN250 (Φ273x6)		1669	550	735
200	HFG-4020-10"			40芯								

注: 1、若遇规格、结构变更, 以本公司提供的最新数据为准; 有关更新内容请关注本公司网站: www.hefil.com  
 2、本公司接受非表上规格过滤网产品的订货。

Note: 1. In case of specifications or structures changes, HEFIL will provide up-to-date data on website: www.hefilter.com.  
 2. HEFIL makes various of other models' HRU replaced hepa box which are not listed in above table. Please consult with us if you need.

# HJD STAINLESS STEEL MULTI-BAG FILTER

## HJD 不锈钢多袋式过滤器



### 材质说明 Material Instructions

材质: SUS304、SUS316L  
 接口型式: 法兰  
 密封材料: 丁晴密封圈、氟胶密封圈  
 密封型式: O型密封圈  
 适用滤袋: 2号滤袋  
 设计压力: 1.0 Mpa  
 设计流量: 80-600 m<sup>3</sup>/H  
 表面处理: 喷砂或抛光

Material: SUS304、SUS316L  
 Interface type: flange  
 Seal material: Butadiene seal, fluorine rubber seal  
 Seal type: O-ring  
 Applicable filter bag: No.2 filter bag  
 Design pressure: 1.0 Mpa  
 Design flow rate: 80-600 m<sup>3</sup>/H  
 Surface treatment: sandblasting or polishing

# HJD STAINLESS STEEL MULTI-BAG FILTER

## HJD 不锈钢多袋式过滤器

### 产品介绍 Production Introduction

HJD多袋式过滤器是一种结构新颖、体积小、操作简便灵活、节能、密闭工作、适用性强的多用途过滤设备。袋式过滤器是一种压力式过滤装置，主要有过滤筒体、过滤筒盖和快开机构、不锈钢滤袋加强网等主要部件组成，滤液由过滤器外壳的旁侧入口管流入滤袋，滤袋本身是装置在加强网篮内，液体透过所需要细度等级的滤袋即能获得合格的滤液，杂质颗粒被滤袋过滤，更换滤袋十分方便，过滤基本无物料消耗。

HJD STAINLESS STEEL MULTI-BAG FILTER equipment with novel structure, small size, easy and flexible operation, energy saving, airtight work and strong applicability. Bag filter is a kind of pressure filtration device, mainly consisting of main components such as filter cylinder body, filter cylinder cover and quick-opening mechanism, stainless steel filter bag reinforcing net, etc. The filtrate flows into the filter bag from the side inlet pipe of the filter shell, and the filter bag itself is installed in the reinforcing net basket, so the liquid penetrates through the filter bag of the required fineness level to obtain qualified filtrate, and the impurity particles are filtered by the filter bag. No material consumption.

### 优势 Advantage

- ◆ 结构紧凑，尺寸合理，地面积较小
- ◆ 过滤精细，适合于细微颗粒或悬浮物，过滤范围可从0.5—200微米
- ◆ 过滤器免清洗，更换液体过滤袋方便快捷，省工省时
- ◆ 处理流量大，过滤阻力小，过滤效率高
- ◆ 使用寿命长和过滤成本低
- ◆ Compact structure, reasonable size, small ground area
- ◆ Fine filtration, suitable for fine particles or suspended matters, the filtration range can be from 0.5 to 200 microns
- ◆ The filter is free of cleaning, and it is convenient and quick to replace the liquid filter bag, saving work and time
- ◆ Large flow rate, low filtration resistance and high filtration efficiency
- ◆ Long service life and low filtration cost

### 应用 Application

- ◆ HJD不锈钢多袋式过滤器具有快开密封结构。O型密封型式，清洗更容量。过滤残液少，更换滤袋十分方便，主要用于油漆、啤酒、化妆品、植物油、电镀液、牛奶、工业用水、糖水、果汁、醋类、树脂、油墨、工业废水。
- ◆ HJD stainless steel multi-bag filter has a quick-open seal structure. O type seal type, cleaning more capacity. Less filtration residual liquid, very convenient to replace the filter bag, mainly used for paint, beer, cosmetics, vegetable oil, electroplating liquid, milk, industrial water, sugar water, juice, vinegar, resin, ink, industrial waste water.

### 结构示意图 Structure Drawings

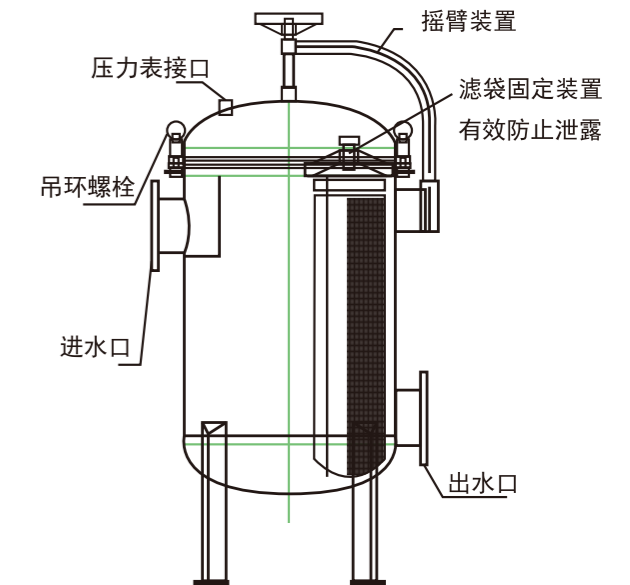

### 常用规格 Common Specifications

型号样式 Model Style	A mm	B mm	C mm	D mm	E mm	F mm	N1	N2	流量 Flow	容积 Volume
HJD-2S2	Φ 400	1090	450	1600	560	400	DN80法兰	DN80法兰	80m <sup>3</sup> /h	100
HJD-2S3	Φ 450	1090	450	1615	610	440	DN80法兰	DN80法兰	120m <sup>3</sup> /h	130
HJD-2S4	Φ 500	1090	450	1630	700	480	DN100法兰	DN100法兰	160m <sup>3</sup> /h	160
HJD-2S5	Φ 550	1090	450	1645	750	510	DN100法兰	DN100法兰	200m <sup>3</sup> /h	190
HJD-2S6	Φ 650	1140	500	1670	890	585	DN125法兰	DN125法兰	240m <sup>3</sup> /h	270
HJD-2S7	Φ 650	1140	500	1670	890	585	DN125法兰	DN125法兰	280m <sup>3</sup> /h	270
HJD-2S8	Φ 700	1140	500	1690	950	620	DN150法兰	DN150法兰	320m <sup>3</sup> /h	320
HJD-2S10	Φ 800	1320	650	1850	1100	690	DN200法兰	DN200法兰	400m <sup>3</sup> /h	410
HJD-2S12	Φ 900	1320	650	1870	1200	760	DN200法兰	DN200法兰	480m <sup>3</sup> /h	530
HJD-2S15	Φ 1000	1320	650	1890	1300	830	DN200法兰	DN200法兰	600m <sup>3</sup> /h	700

注: 1、若遇规格、结构变更, 以本公司提供的最新数据为准; 有关更新内容请关注本公司网站: www.hefil.com  
 2、本公司接受非表上规格过滤网产品的订货。

Note: 1. In case of specifications or structures changes, HEFIL will provide up-to-date data on website: www.hefilter.com.  
 2. HEFIL makes various of other models' HRU replaced hepa box which are not listed in above table. Please consult with us if you need.



# HCFL PTFE MEMBRANE MEDIA FILTER CARTRIDGE

## HCFE 聚四氟乙烯微孔膜折叠式滤芯

### 产品介绍 Production Introduction

HCFE聚四氟乙烯微孔膜折叠式滤芯广泛应用于压缩空气、生物反应器、储罐、配料罐进气排气的除菌过滤，电子工业高纯气体和有机溶剂除菌过滤。

HCFE PTFE Microporous Membrane Filter Cartridge is widely used for sterilization and filtration of compressed air, biological reactor, storage tank, dosing tank inlet and exhaust, and sterilization and filtration of high-purity gas and organic solvent in electronic industry.



### 材质说明 Material Instructions

滤料: 进口聚四氟乙烯微孔膜及进口无纺布或丝网支撑层折叠  
骨架材质: 滤芯外筒、芯柱、端盖均为增强型聚丙烯材质各部分密封采用先进的熔焊技术成型, 无任何粘接剂

Media: Pleated of imported PTFE membrane and imported non-woven cloth or mesh support layer  
Skeleton material: The outer cylinder, core column and endcover are all made of reinforced polypropylene  
Each part of the seal is formed by advanced fusion welding technology, without any adhesive

# HCFL PTFE MEMBRANE MEDIA FILTER CARTRIDGE

## HCFE 聚四氟乙烯微孔膜折叠式滤芯



### 优势 Advantage

- ◆ 滤膜具有极强的疏水性
- ◆ 潮湿或干燥条件下均能确保除菌
- ◆ 用于气体过滤时, 能100%截留0.01μm以上细菌、噬菌体
- ◆ 具有好的化学耐受性和热稳定性, 耐高温, 耐冲击, 耐腐蚀
- ◆ 流量大, 压差低, 使用寿命长
- ◆ 每支滤芯经完整性检测
- ◆ The membrane is extremely hydrophobic
- ◆ Ensures sterilization under both humid and dry conditions
- ◆ 100% retention of bacteria and phages above 0.01μm when used for gas filtration
- ◆ Good chemical resistance and thermal stability, high temperature resistance, impact resistance, and corrosion resistance
- ◆ High flow rate, low differential pressure and long service life
- ◆ Each cartridge is tested for integrity

### 应用 Application

- ◆ 压缩空气、生物反应器、储罐、配料罐进气排气的除菌过滤, 电子工业高纯气体和有机溶剂除菌过滤
- ◆ Sterilization and filtration of compressed air, bioreactor, storage tank, dosing tank inlet and exhaust, electronic industry High purity gas and organic solvent filtration

### 常用规格 Common Specifications

过滤精度 Filtration accuracy	气体 Gases	0.01 μm, 0.05 μm
	液体 Liquid	0.01 μm, 0.22 μm, 0.45 μm
滤芯长度		5", 10", 20", 30", 40"
滤芯直径		Φ 69mm
过滤面积/10" 长度		0.6m²
最高工作温度		90°C (压差0.2MPa时)
最高工作压力		4.0MPa@25°C
正向耐压差		0.4MPa@25°C
反向耐压差		0.3MPa@25°C
蒸汽灭菌		125°C, 每次30min
接口形式		226卡入式
O型密封圈材料		氟橡胶, 硅橡胶

注: 1. 若遇规格、结构变更, 以本公司提供的最新数据为准; 有关更新内容请关注本公司网站: www.hefil.com

2. 本公司接受非表上规格过滤网产品的订货。

Note: 1. In case of specifications or structures changes, HEFIL will provide up-to-date data on website: www.hefilter.com.

2. HEFIL makes various of other models' HRU replaced hepa box which are not listed in above table. Please consult with us if you need.

### 空气流量-压力差特性 (10" 滤芯)

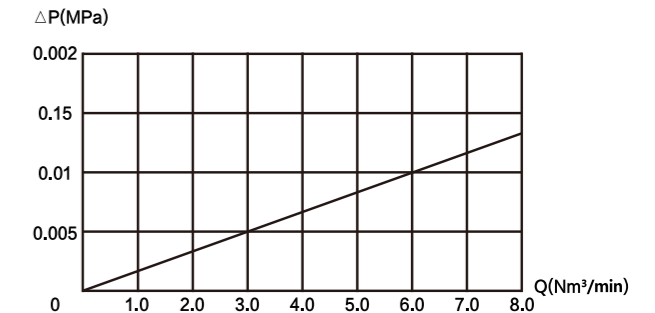

# HCPP PP MEDIA FILTER CARTRIDGE

## HCPP 聚丙烯折叠式滤芯



### 材质说明 Material Instructions

产品名称: 聚丙烯折叠滤芯  
 材质: 100%聚丙烯  
 滤芯外径: 68mm  
 工作温度:  $\leq 82^{\circ}\text{C}$   
 过滤精度: 0.1-100u  
 工作压差:  $\leq 0.4\text{Mpa}$   
 规格尺寸: 5-40英寸 (125-1016mm)  
 膜材质: PP、PE、PTFE、尼龙

Product name: Polypropylene folded cartridge  
 Material: 100% polypropylene  
 Outer diameter of cartridge: 68mm  
 Working temperature:  $\leq 82^{\circ}\text{C}$   
 Filtration precision: 0.1-100u  
 Working pressure difference:  $\leq 0.4\text{Mpa}$   
 Specification size: 5-40 inches (125-1016mm)  
 Membrane material: PP, PE, PTFE, nylon

# HCPP PP MEDIA FILTER CARTRIDGE

## HCPP 聚丙烯折叠式滤芯

### 产品介绍 Production Introduction

HCPP聚丙烯折叠式滤芯是由聚丙烯超细纤维热熔缠结制成, 纤维在空间随机形成三维微孔结构, 滤芯外壳、中心杆、端盖均采用热熔焊接技术, 不含任何胶合剂, 洁净环境生产, 无污染, 无泄漏, 具有广泛性的化学兼容性。

HCPP PP MEDIA FILTER CARTRIDGE is made of polypropylene ultra-fine fiber hot melt entangled, the fiber randomly forms three-dimensional microporous structure in space, the cartridge shell, central rod and end cap are all made by hot melt welding technology without any adhesive, clean environment production, no pollution, no leakage, and wide chemical compatibility.

### 优势 Advantage

- 采用超细聚丙烯纤维过滤材料及进口无纺布或丝网支撑层折叠
- 全聚丙烯结构, 热熔焊技术密封成型, 无粘接剂, 无纤维脱落
- 孔径分布均匀, 过滤精度高, 压差低, 纳污量较大, 使用寿命长
- 具有广泛的化学相容性, 应用广泛, 便宜
- 流支滤芯孔径检验, 且经高纯水冲洗
- Ultra-fine polypropylene fiber filter material and imported non-woven fabric or screen support layer folding
- All polypropylene structure, sealed and shaped by hot welding technology, no adhesive, no fiber shedding
- Uniform pore size distribution, wide filtration precision, low differential pressure, large dirt holding capacity and long service life
- Wide chemical compatibility, wide application and low cost
- Flow branch cartridge pore size test, and flushed by high purity water

### 应用 Application

- 制药工业各种药液过滤, 食品工业中饮用水、酒类、果汁等过滤, 化学工业有机溶剂过滤, 电子工业高纯水预过滤, 油田注水过滤
- The filtration of organic solvents in the chemical industry, the pre-filtration of high-purity water in the electronics industry, the filtration of oilfield water injection

### 常用规格 Common Specifications

过滤精度	0.05 $\mu\text{m}$ , 0.1 $\mu\text{m}$ , 0.2 $\mu\text{m}$ , 0.5 $\mu\text{m}$ , 1 $\mu\text{m}$ , 3 $\mu\text{m}$ , 5 $\mu\text{m}$ , 10 $\mu\text{m}$ , 20 $\mu\text{m}$ , 30 $\mu\text{m}$ , 50 $\mu\text{m}$
滤芯长度	5" , 10" , 20" , 30" , 40"
滤芯直径	$\Phi 69\text{mm}$
过滤面积/10" 长度	0.6m <sup>2</sup>
最高工作温度	80 $^{\circ}\text{C}$ (压差0.12MPa时)
最高工作压力	1.6MPa@25 $^{\circ}\text{C}$
正向耐压差	0.4MPa@25 $^{\circ}\text{C}$
反向耐压差	0.3MPa@25 $^{\circ}\text{C}$
蒸汽灭菌	121 $^{\circ}\text{C}$ , 每次30min
接口形式	222插入式, 226卡入式, 平面压入式
O型密封圈材料	氟橡胶, 硅橡胶, 乙丙橡胶

注: 1. 若遇规格、结构变更, 以本公司提供的最新数据为准; 有关更新内容请关注本公司网站: www.hefil.com

2. 本公司接受非表上规格过滤网产品的订货。

Note: 1. In case of specifications or structures changes, HEFIL will provide up-to-date data on website: www.hefilter.com.

2. HEFIL makes various of other models' HRU replaced hepa box which are not listed in above table. Please consult with us if you need.

### 空气流量-压力差特性 (10" 滤芯)

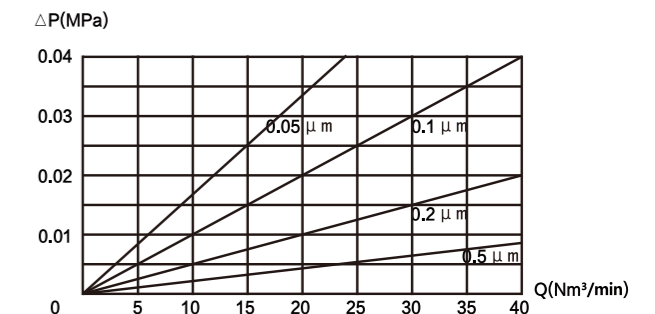

# HDPE LIQUID FILTER BAG

## HDPE 过滤袋



### 材质说明 Material Instructions

材质: 100%聚丙烯  
 滤芯外径: 68mm  
 工作温度:  $\leq 82^{\circ}\text{C}$   
 过滤精度: 0.1-100u  
 工作压差:  $\leq 0.4\text{Mpa}$   
 规格尺寸: 5-40英寸 (125-1016mm)  
 膜材质: PP、PE、PTFE、尼龙  
 Material: 100% polypropylene  
 Outer diameter of cartridge: 68mm  
 Working temperature:  $\leq 82^{\circ}\text{C}$   
 Filtration precision: 0.1-100u  
 Working pressure difference:  $\leq 0.4\text{Mpa}$   
 Specification size: 5-40 inches (125-1016mm)  
 Membrane material: PP, PE, PTFE, nylon

# HDPE LIQUID FILTER BAG

## HDPE 过滤袋

### 产品介绍 Production Introduction

HDPE过滤袋是由聚酯纤维滤布, 纯纤维以针刺方式制造而成, 形成立体、高度蓬松的三维深度, 迂回曲折的过滤层。其特点是纤维组织疏松, 从而增加了杂质的容量; 该产品是属复式截流模式, 有效地清除固体及软性颗粒, 即较大的颗粒杂质被截留在纤维表面, 而细微颗粒则被捕捉于滤材深层中, 确保使用过程中不会因压力增大而破损, 具有较高过滤效率。

HDPE Liquid Filter Bag is made of polyester fiber filter cloth, pure fiber manufactured by needle-punching, forming a three-dimensional, highly fluffy three-dimensional depth, meandering filter layer. It is characterized by loose fiber organization, thus increasing the capacity of impurities; the product is of compound interception mode, effectively removing solid and soft particles, i.e. larger particles of impurities are trapped on the fiber surface, while fine particles are captured in the deep layer of the filter material, ensuring that it will not be broken during use due to increased pressure and has high filtration efficiency.

### 优势 Advantage

- ◆ 缝合方式: 超声波熔接或线缝合
- ◆ 密封环: 聚丙烯和聚酯SDS、STS、镀锌钢或不锈钢钢圈
- ◆ 密封环连接方式: 超声波熔接或线缝合
- ◆ 过滤精度范围: 1、3、5、10、25、50、75、100、150、200  $\mu\text{m}$
- ◆ 效率: 相对精度, 单次过滤效率为90%
- ◆ 表面处理: 防止纤维和溶出物游离的表面光滑处理
- ◆ 材料等级: 完全符合FDA等级要求, 无硅和其他类型的污染物
- ◆ 高流量, 低压降。更换压差为0.10MPa, 更换压差不可超0.18MPa
- ◆ 广泛的化学兼容性
- ◆ Stitching method: ultrasonic fusion or wire stitching
- ◆ Sealing ring: polypropylene and polyester SDS, STS, galvanized steel or stainless steel ring
- ◆ Sealing ring connection method: ultrasonic fusion or wire stitching
- ◆ Filtration precision range: 1, 3, 5, 10, 25, 50, 75, 100, 150, 200  $\mu\text{m}$
- ◆ Efficiency: relative precision, single filtration efficiency of 90%
- ◆ Surface treatment: smooth surface treatment to prevent fibers and dissolved materials from freeing
- ◆ Material grade: Full compliance with FDA grade requirements, no silicon and other types of contaminants
- ◆ High flow rate and low pressure drop. The replacement pressure difference is 0.10MPa, and the replacement pressure difference cannot exceed 0.18MPa
- ◆ Wide range of chemical compatibility

### 应用 Application

- ◆ 主要用于食品饮料工业、电子工业、制药工业、化工工业的纯化水及溶液的处理
- ◆ Mainly used in process water and solutions of purifying in food, beverage, electronic, pharmaceuticals, chemical industries

### 常用规格 Common Specifications

产品型号 Product Model	产品尺寸 Product Size
1号袋	$\phi 180\text{mm} \times 410\text{mm}$
2号袋	$\phi 180\text{mm} \times 810\text{mm}$
3号袋	$\phi 102\text{mm} \times 210\text{mm}$
4号袋	$\phi 102\text{mm} \times 380\text{mm}$

注: 1、若遇规格、结构变更, 以本公司提供的最新数据为准; 有关更新内容请关注本公司网站: [www.hefil.com](http://www.hefil.com)  
 2、本公司接受非表上规格过滤网产品的订货。  
 Note: 1. In case of specifications or structures changes, HEFIL will provide up-to-date data on website: [www.hefilter.com](http://www.hefilter.com).  
 2. HEFIL makes various of other models' HRU replaced hepa box which are not listed in above table. Please consult with us if you need.